

Team Champlone Kids

1st^B SJBJJ (Saint Joseph)

2nd Wichita Jiu Jitsu Club

3rd Rivers BJJ

Adult

1st Rivers BJJ

2nd Laselva MMA

3rd Combatives Sports Center

Overall

1st Saint Joseph BJJ

2nd Rivers BJJ

3rd Wichita Jiu Jitsu Club

Adult Team Points

Rivers - 9, 9, 9, 9, 3, 9, 1, 3, 1, 3, 1, 1, 9, 3, 1, 3, 1, 3, 3, 3, 1, 3, 9, 1, 9, 1

RS MMA - 9, 9

~~River~~ 1, 3, 9, 1, 9, 3, 1
~~(134)~~ ~~(138)~~

Valer - 3, 3, 3, 1, 9, 9, 3, 9, 1, 9

1st Rhers
 2nd Laselva
 3rd CCC

Lawrence bjj - 9, 3, 9, 1, 9, 9

Cast Iron - 1, 3, 9, 9, 9, 9, 3, 3, 9, 9, 9, 9, 9, 3, 3, 9

Wave man - 1

Outkast - 1, 3, 3, 3, 1

WJC - 1, 3, 1, 1, 9, 3, 9, 3, 1, 9, 9, 3, 3, 3, 1, 3, 9, 3, 1, 3, 1, 9 = ~~(68)~~

Laselva - 9, 1, 1, 1, 9, 3, 3, 9, 9, 3, 9, 3, 9, 1, 1, 1, 3, 9, 1, 3, 9, 3, 3, 9, 3, 9, 9, 1

KCBS - 3, 1, 9, 3, 3, 9, 9, 9, 1, 1, 3

1, 3
~~(138)~~

Crigni - 3, 3, 1, 3, 3, 1, 1, 1, 1, 9, 1, 3, 3, 9, 3, 9, 1, 9, 1, 3, 9, 1, 3, 1, 3, 9, 3
 3, 9, 3, ~~(121)~~, 1, ~~(123)~~

St. Joe - 9, 3, 3, 3, 1, 3, 9, 1, 1, 3, 9, 9, 3, 3, 3, 3, 1, 3, 1 = (70)

Thatchers - 3, 3

E: 3 - 9, 9, 9, 3

SOMMA - 1

CSC - 1, 9, 1, 3, 3, 9, 3, 3, 9, 9, 9, 3, 3, 1, 9, 1, 9, 3, 9, 1, 9, 3, 9 = ~~(49)~~

Rhino - 3, 3

Prophecy - 9, 1, 1, 9, 9

NCD (Indo/BSS) - 3, 1

Elite - 9, 9

Chute boxe - 9, 3, 9

Lanisberg - 9, 3, 1, 9, 3 valley - 9

welcome - 1
 JMTK - 1
 TJJ - 1
 Kronos - 3, 1

ATT - 9, 1, 1, 9, 9, 3, 9, 9

~~(49)~~
~~(129)~~
 (31)

1st - 1
2nd - 3
3rd - 1

Kids Team Points

Rivers B)) - 1, 9, 3, 3, 3, 3, 1, 3, 9, 9, 3, 1, 3, 3, 1, 1, 1, 1, 9, 3, 1
(72)

~~1st - St. Joe~~
1st - St. Joe
2nd - WSS
3rd - Rivers

KCB)) - 1, 3, 9, 9, 3, 3, 9, 9, 9, 1, 3 - (60)^{6th}

Shutebox - 1, 9 - (10)

Criqui - 3, 3, 3, 1 - (10)

Elite - 3, 9, 1 - (13)

WSS - 9, 1, 3, 3, 9, 3, 9, 1, 9, 1, 1, 9, 9, 3, 3, 3, 1, 3, 9 - (89)

St. Joe - 9, 9, 1, 9, 9, 9, 9, 3, 9, 3, 3, 9, 9, 1, 9, 3, 9, 1, 3, 3, 9, 9, 3, 1, 1, 9 - (E)

Valor - 3, 9, 3, 9, 1, 3, 3, 1, 9, 1, 9, 9, 3 - (63)^{4th}

Fox - 1, 3, 9, 9, 3, 3, 9, 3, 9, 9, 3 - (61)^{5th}

Cast Iron - 3, 1, 3, 1 - (8)

Leselva - 9, 9, 1, 1, 3, 1, 3, 1, 1 - (29)

Outkast - 1, 3, 3 - (7)

E:3 - (9)

No Coast - 9, 3 - (12)

Zenith sub-ind. - 1, 3, 9, 9 - (22)

Warrior Academy - 9, 9 - (18)

CSC - 9, 3 - (12)

ATT - 9, 9 - (18)

Louisberg - 3, 1, 3 - (7)

Lawrence)) - (9) Derby wrest. - (3)

1st
Max

2nd
Cormac

3rd
Zane 2

KIDS MALE - NOGI - 7-9 - 60-69

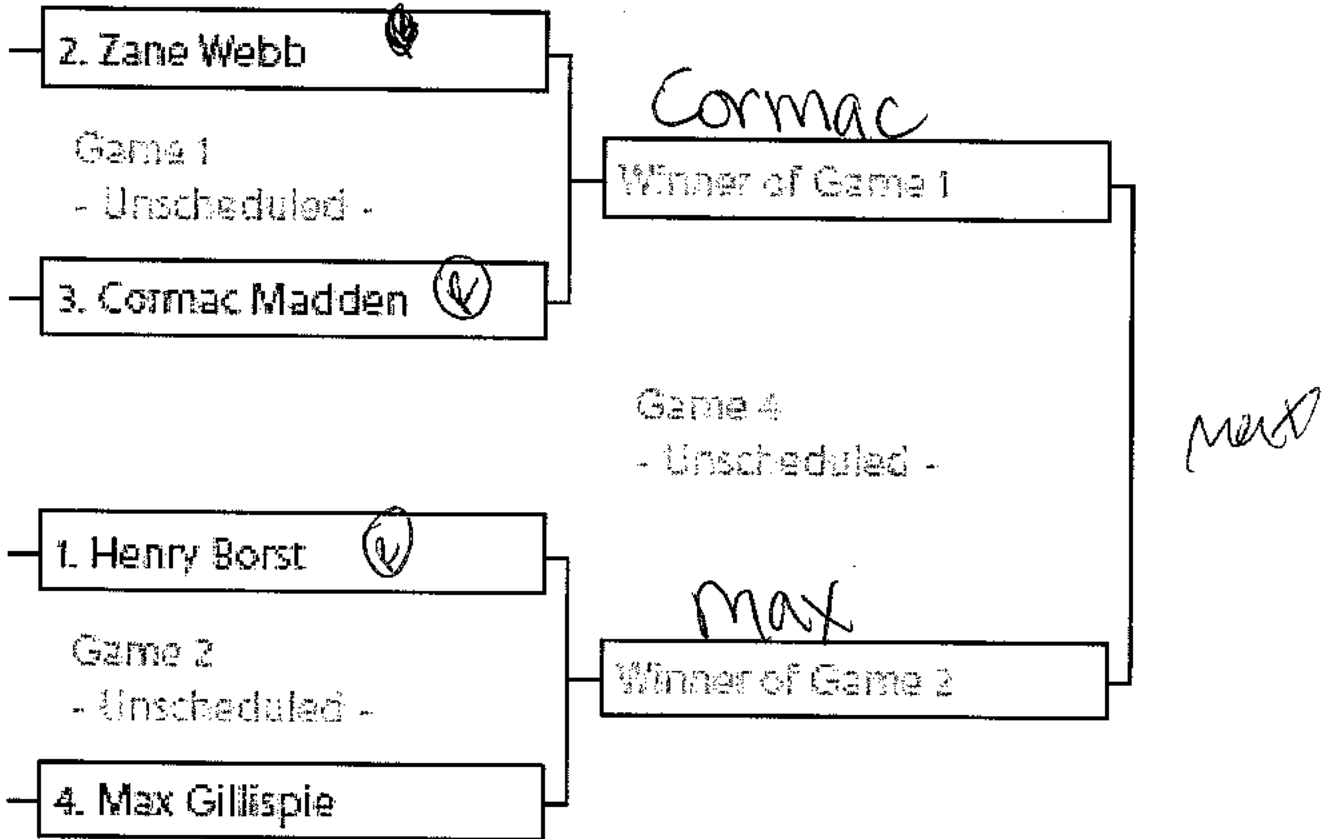

Zane

Henry



KIDS MALE - NOGI - 9-10 - 70-80

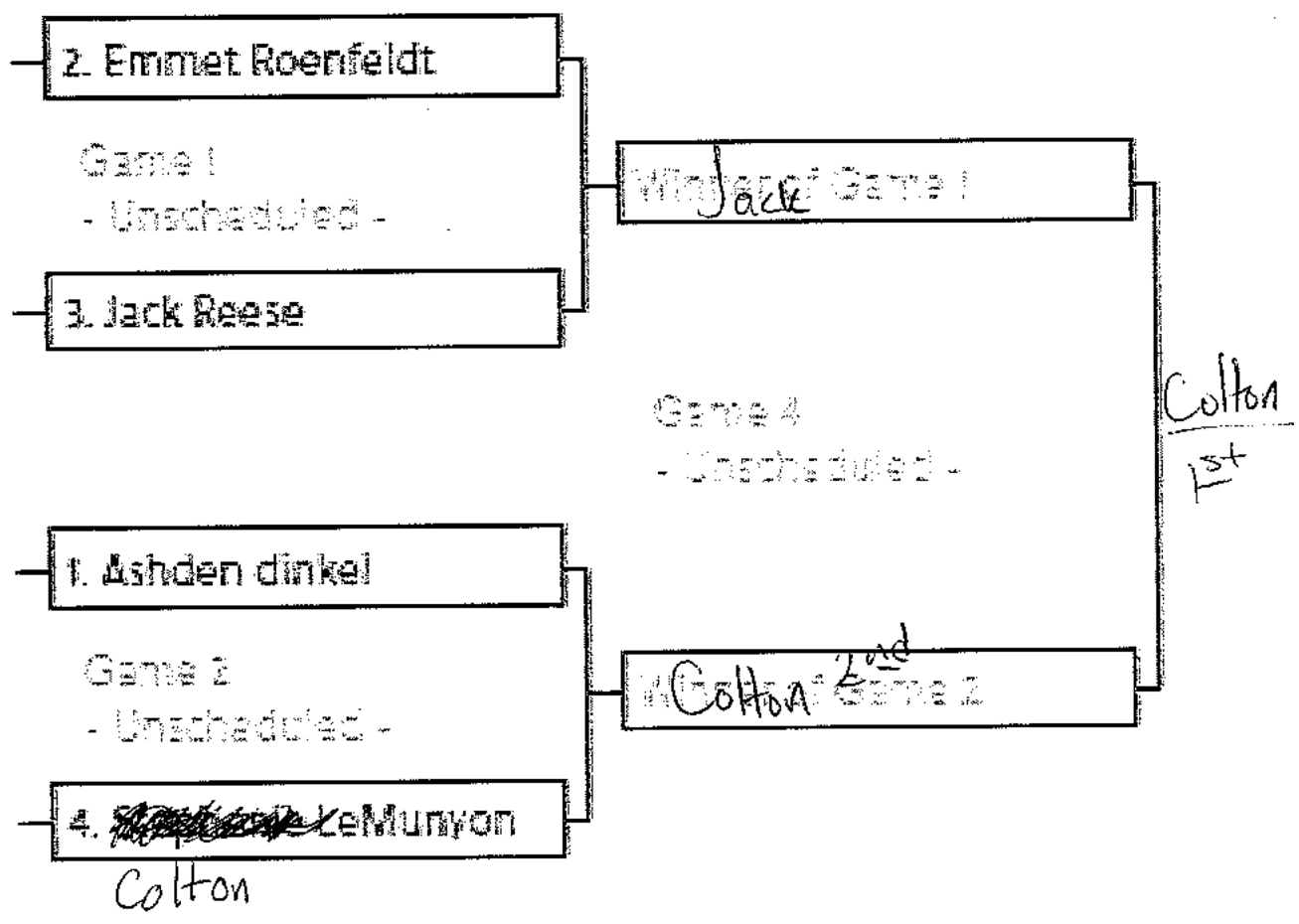

Emmet
Ashden
Ashden
3rd



Kids Male Nbsi Int. 9-10 80-90155

and Luke McCosh

Colin Cummings

~~Sevens~~ FRUCHTING R

Colin R

Colin 1st

Erinmet

3rd

J

KIDS MALE - NOGI - 11-12 Y/O - 70-79 LBS

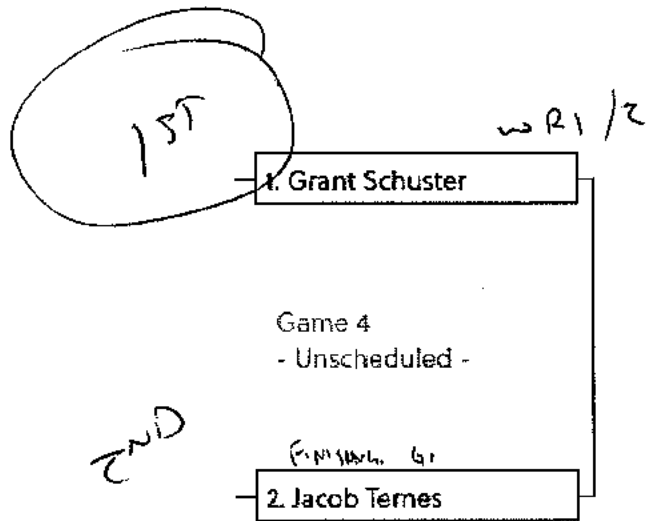

KIDS MALE - NOGI INT - 11-12 - 70-79

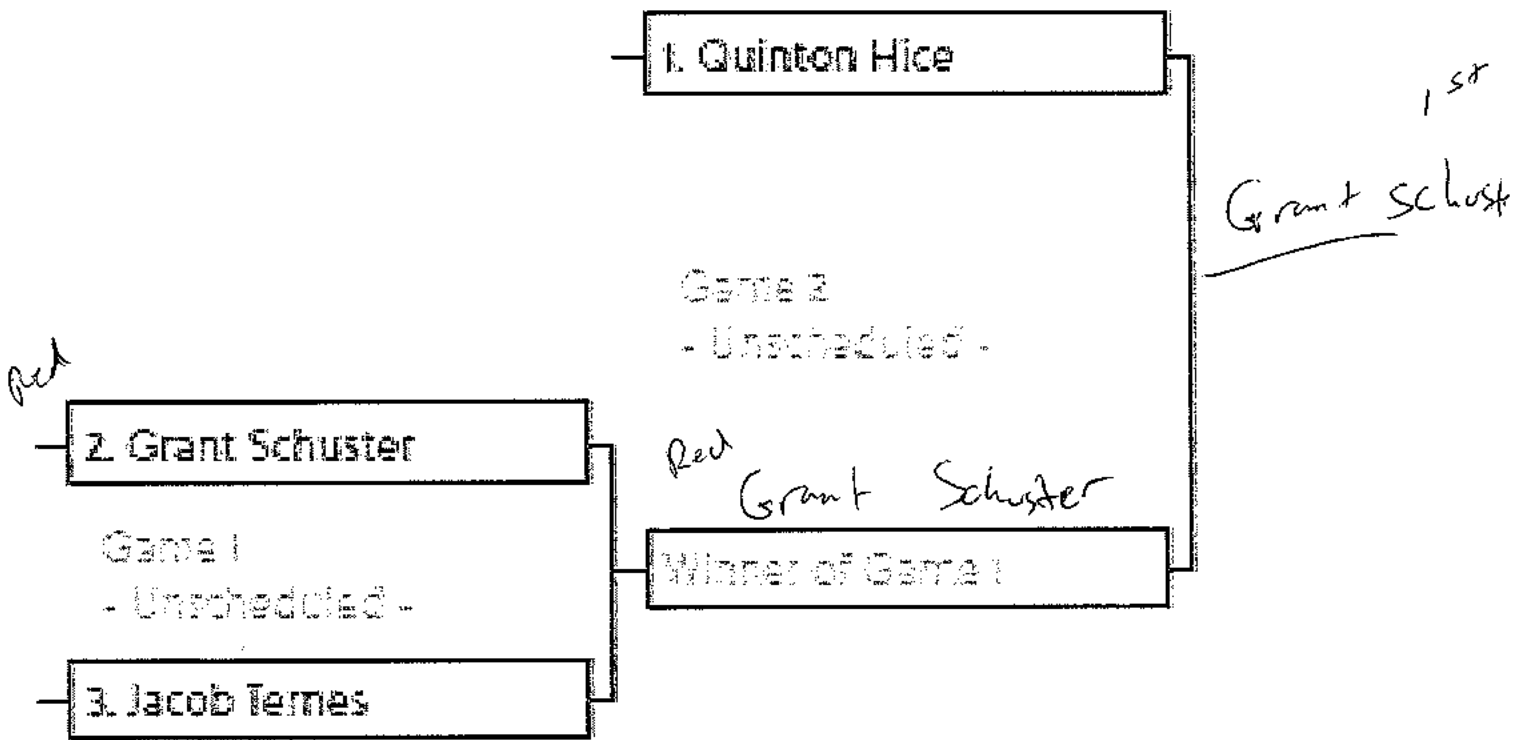

Red 3rd
Quinton

Red
Jacob

Jacob



KIDS MALE - NOGI - 11-12 Y/O - 90-115 LBS

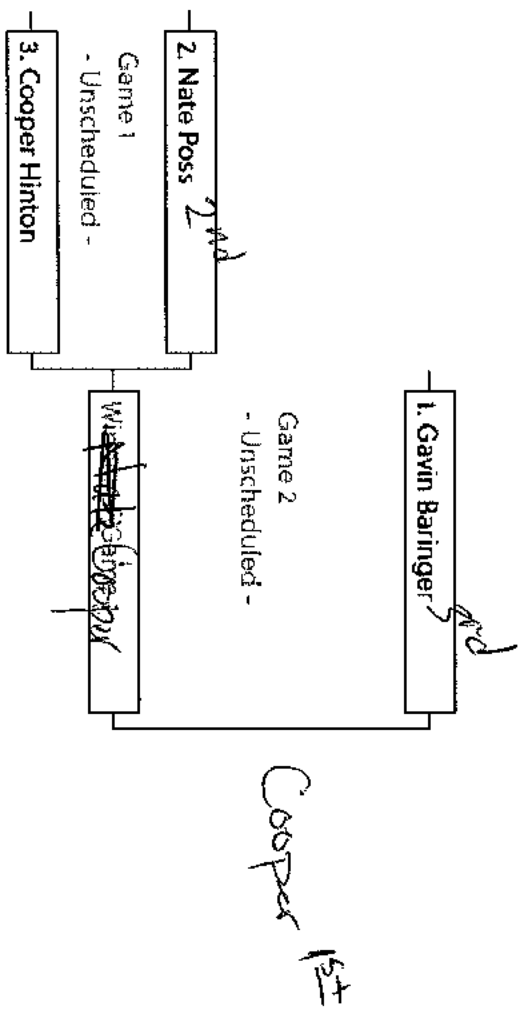

6

KIDS MALE - NOGI INT - 12-13 - 105-120

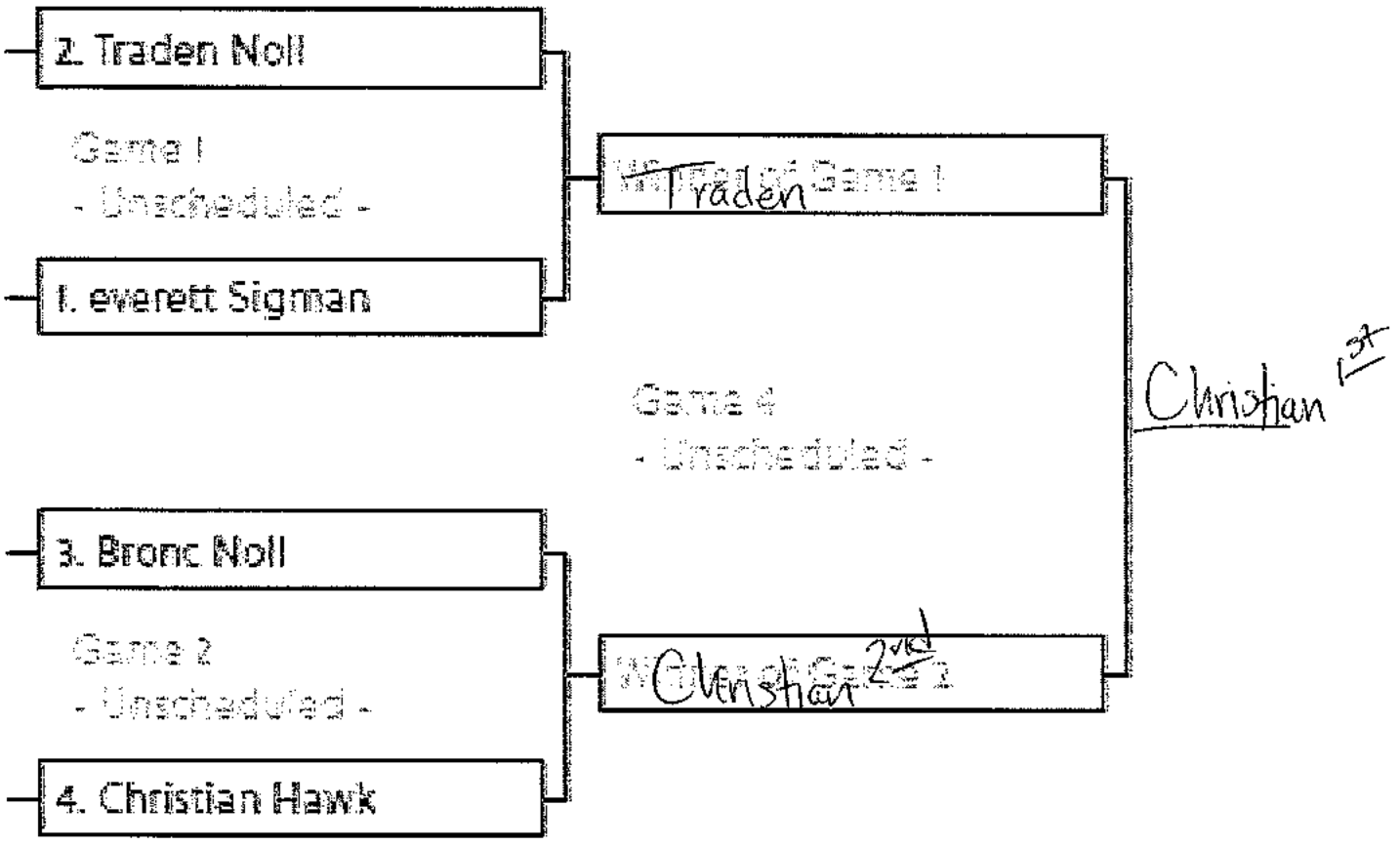

Bronc
 everett
 Everett
 3rd

Delete Bracket

KIDS MALE - NOGI - 12-13 - 124-132

Best 2 of 3

Collin Word

1st Collin Word

2nd Cedance Bushong

~~1. Camden Hinton~~

Game 4
- Unscheduled -

~~2. Jason Stojan~~

Red Cedance Bushong

Blue Collin Word 2-0

Collin

Deletes Bracket Set

| Cedance | Red | Collin |
|-----------|------|--------|
| 2nd Match | 2-0 | |
| Collin | Blue | |

13

KIDS MALE - NOGI - 12-15 Y/O - 121-140 LBS

RND 1 - CAMDEN
RND 2 - CAMDEN

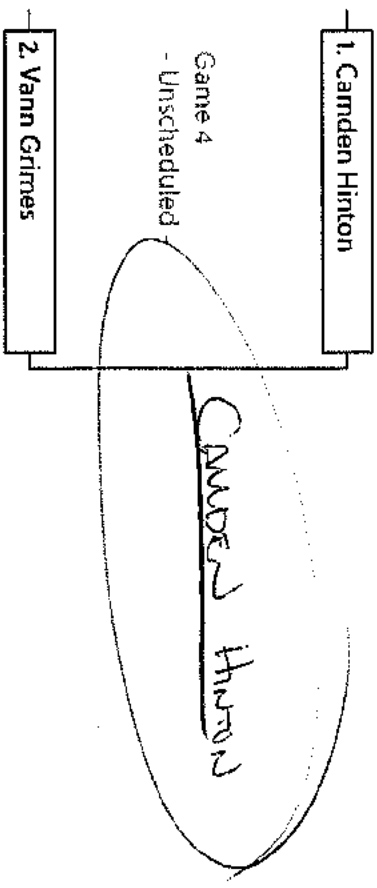

KIDS MALE - NOGI - 13 - 155 - IT5

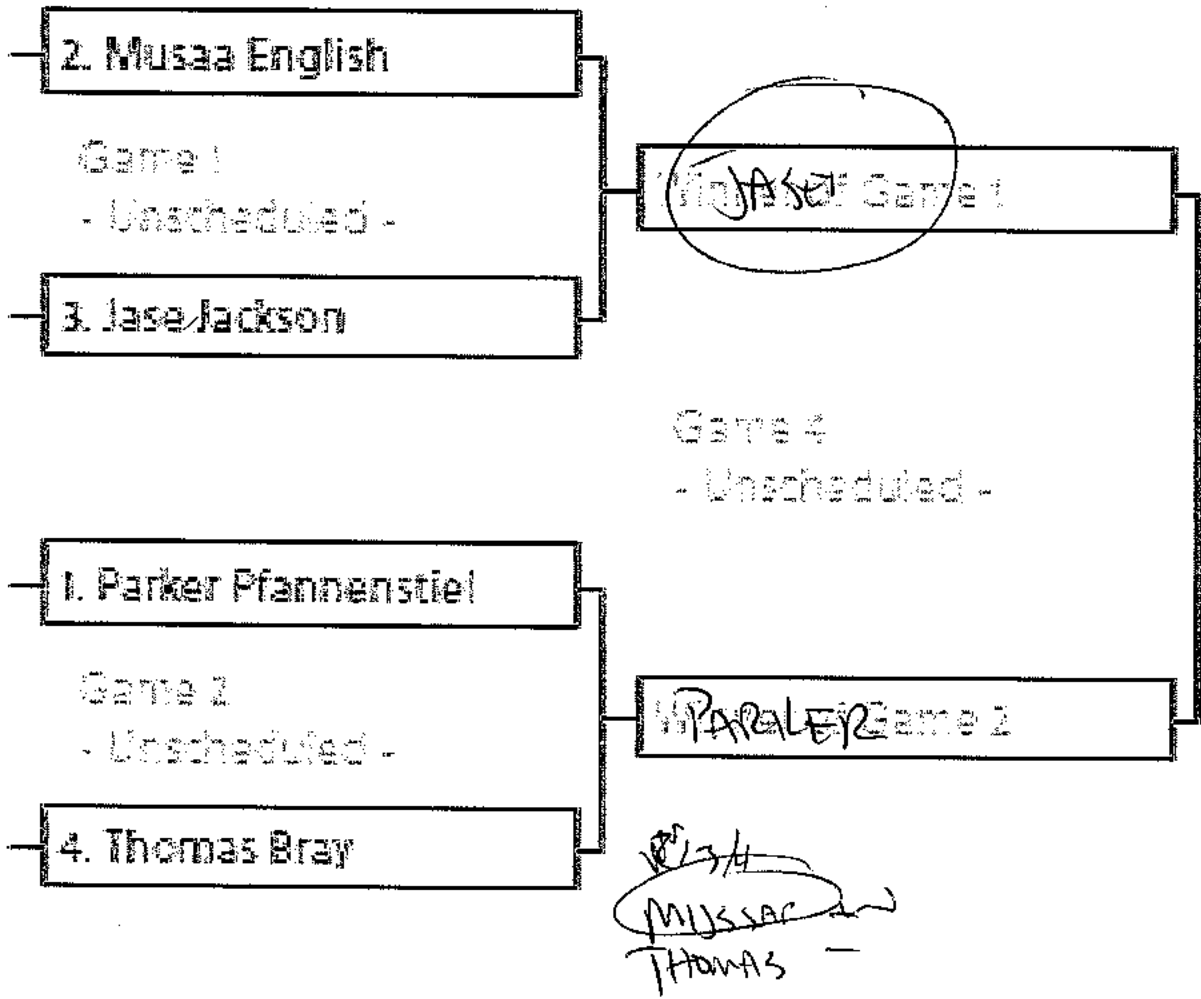

8
B

KIDS MALE - NOGI - 13-15 Y/O - 141-160 LBS

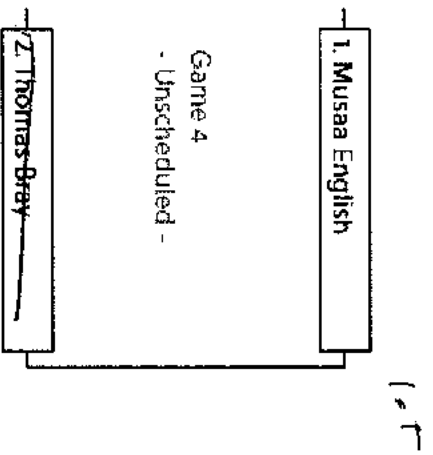

1st Quinn

2nd Kaleb

3rd Anthony²

KIDS MALE - NOGI - 16-17

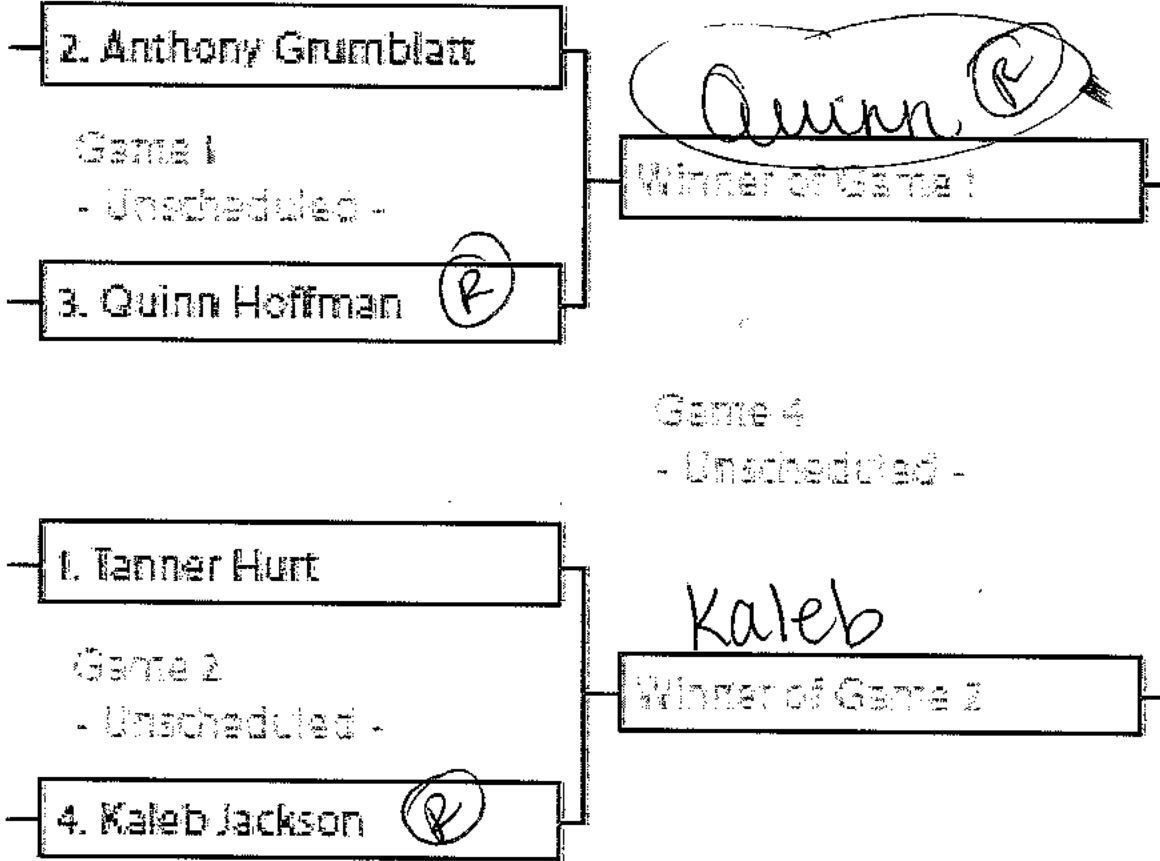

Anthony (P)

Delete from Tanner

KIDS MALE - NOGI INTERMEDIATE - 13-18 Y/O - 141-160 LBS

Shane 1st
Jacob 2nd
Jacob 3rd

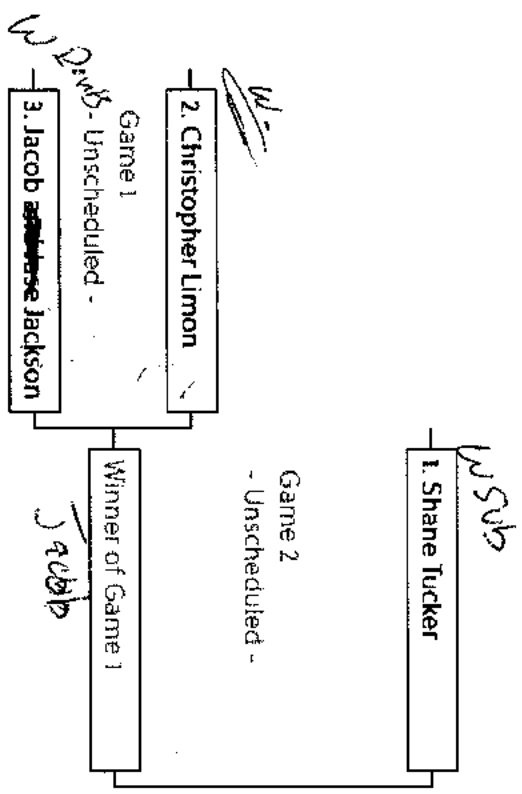

Shane
Chris - W/P

KIDS MALE - NOGI - 16-18 Y/O - 141-153 LBS

PLS

Dakota (out)

1st Owen

2nd

Jonathan

3rd

Dakota

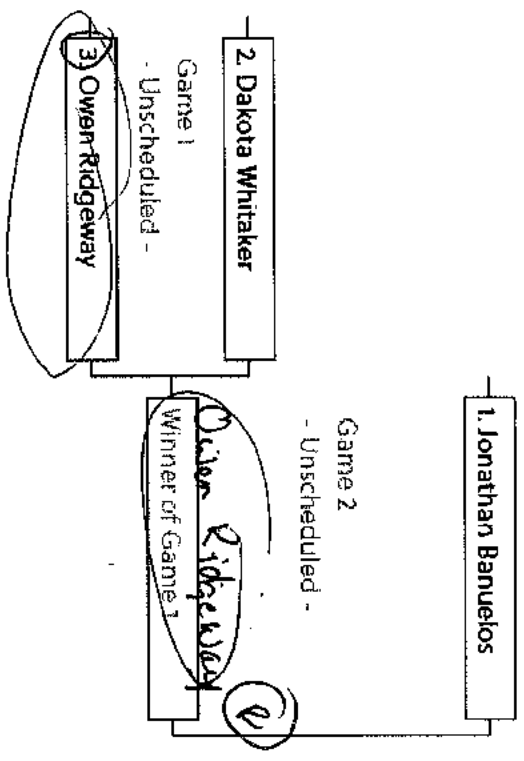

Owen

Jonathan

KIDS MALE - NOGI - 16-18 Y/O - 195-207 LBS

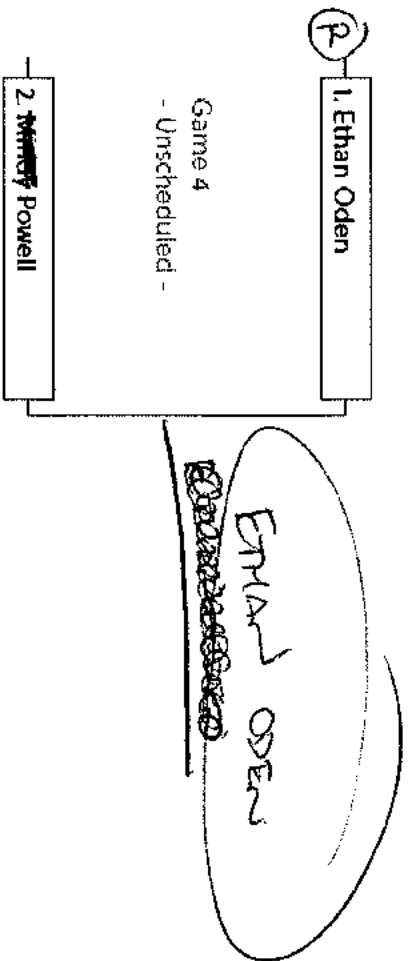

Rod 1 - Emma
Rus 2 - Adkin
~~Rus 3 - Emma~~

Adkin

KIDS M/F - NOGI - 5-6 - BELOW 49

~~XXXXXXXXXX~~

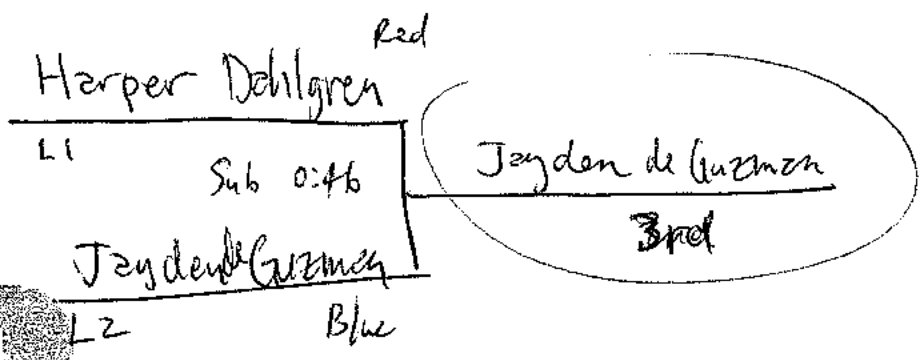
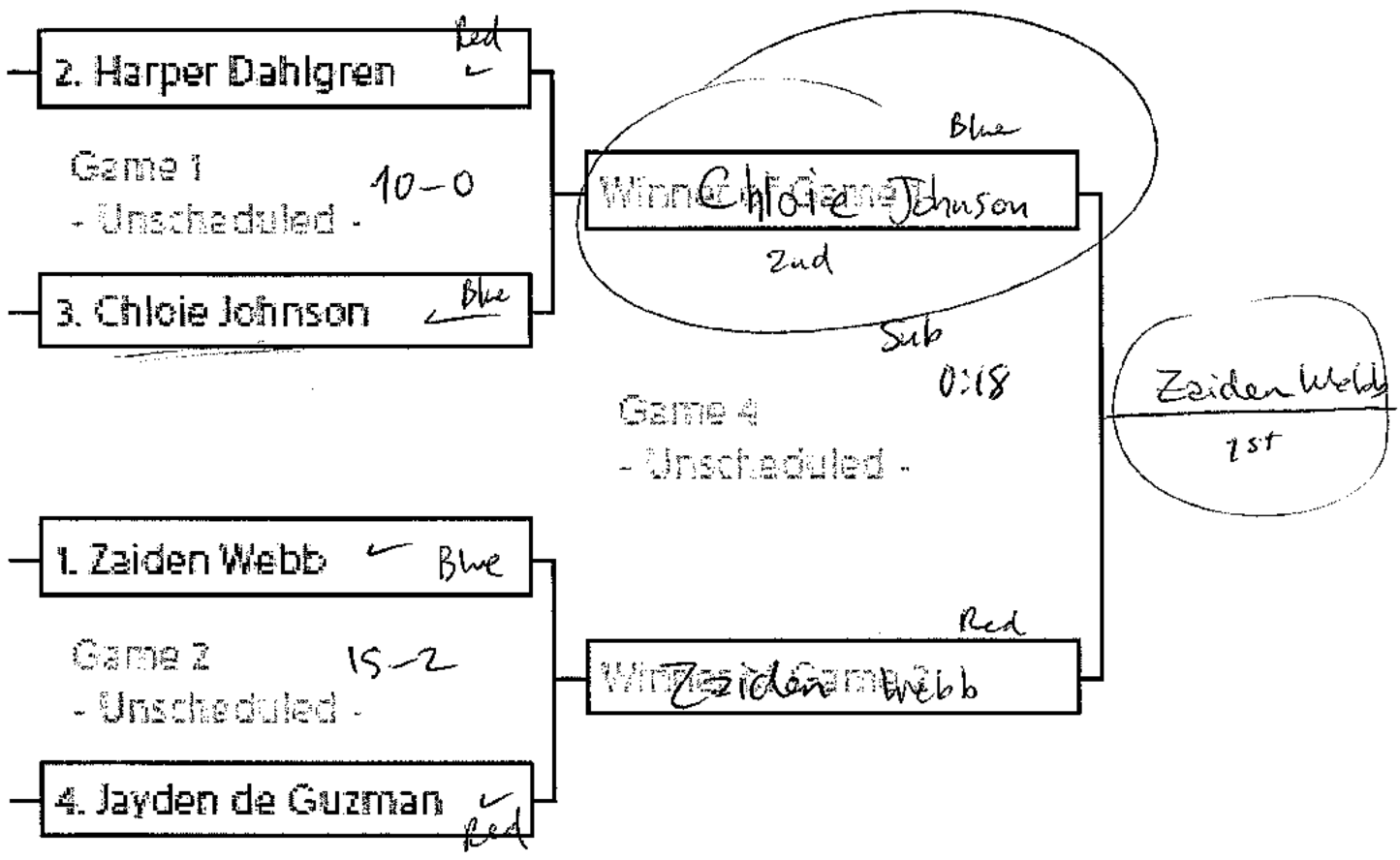

Belate Bracket

KIDS - GI - WHITE/GRAY BELT - 7 & UNDER - 40 LBS & BELOW

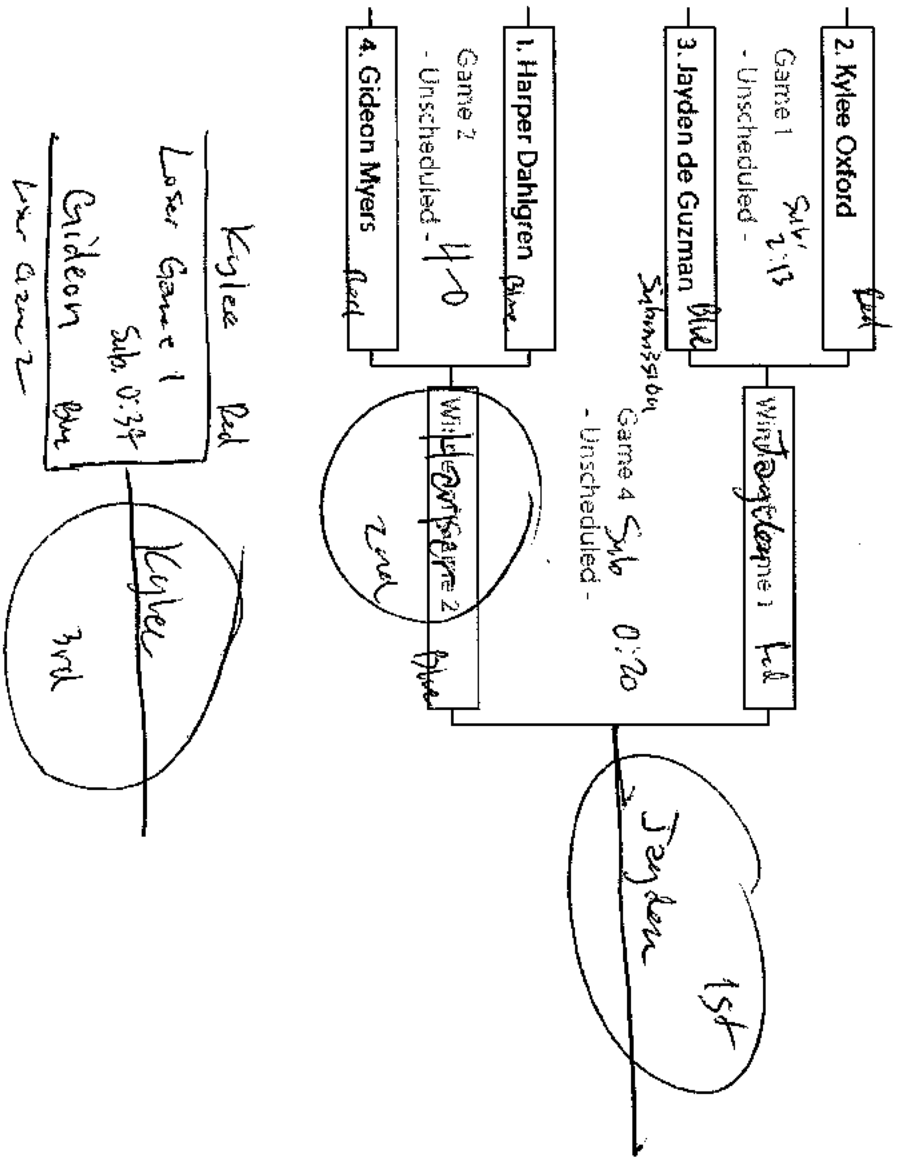



KIDS M/F - NOGI - 6-B - BELOW 49

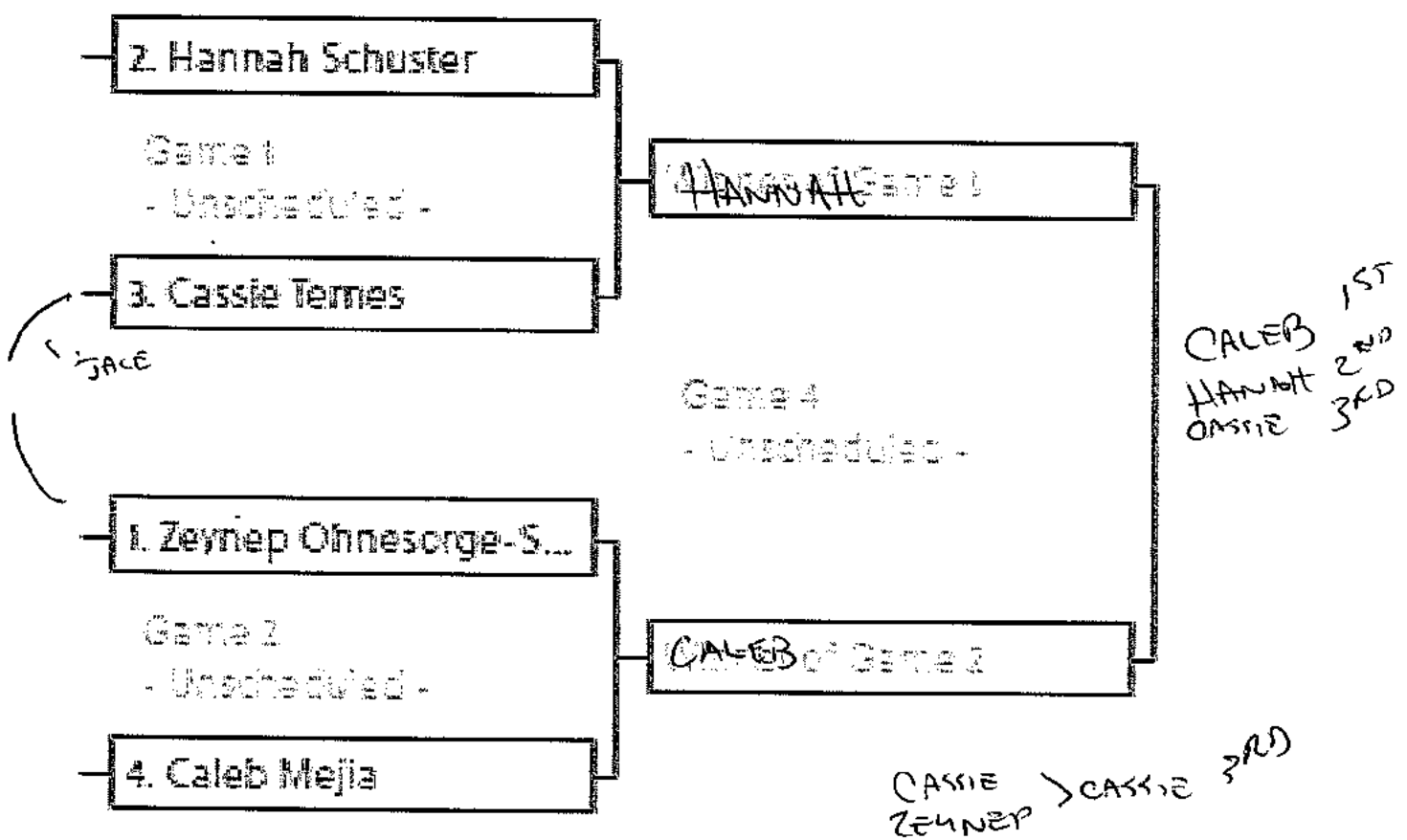

Jace Coder - give 2 matches
against Loser
Bracket
(1st place)

ZEYNEP
JACE

CASSIE
JACE



KIDS M/F - NOGI - 7-9 - 50-59

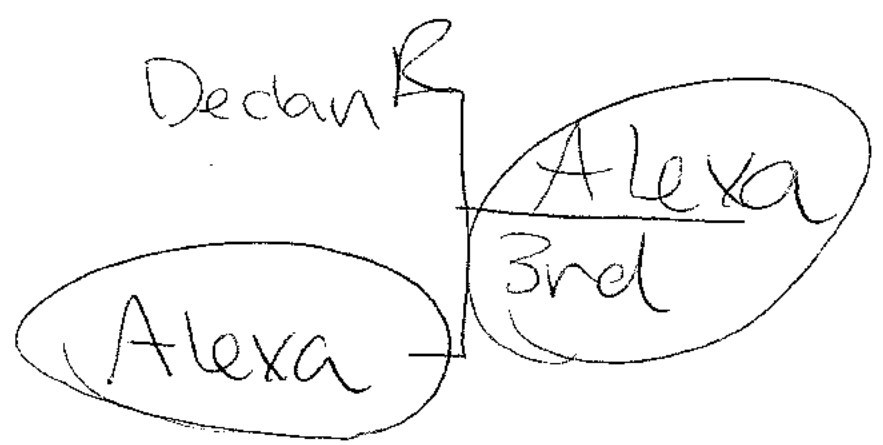
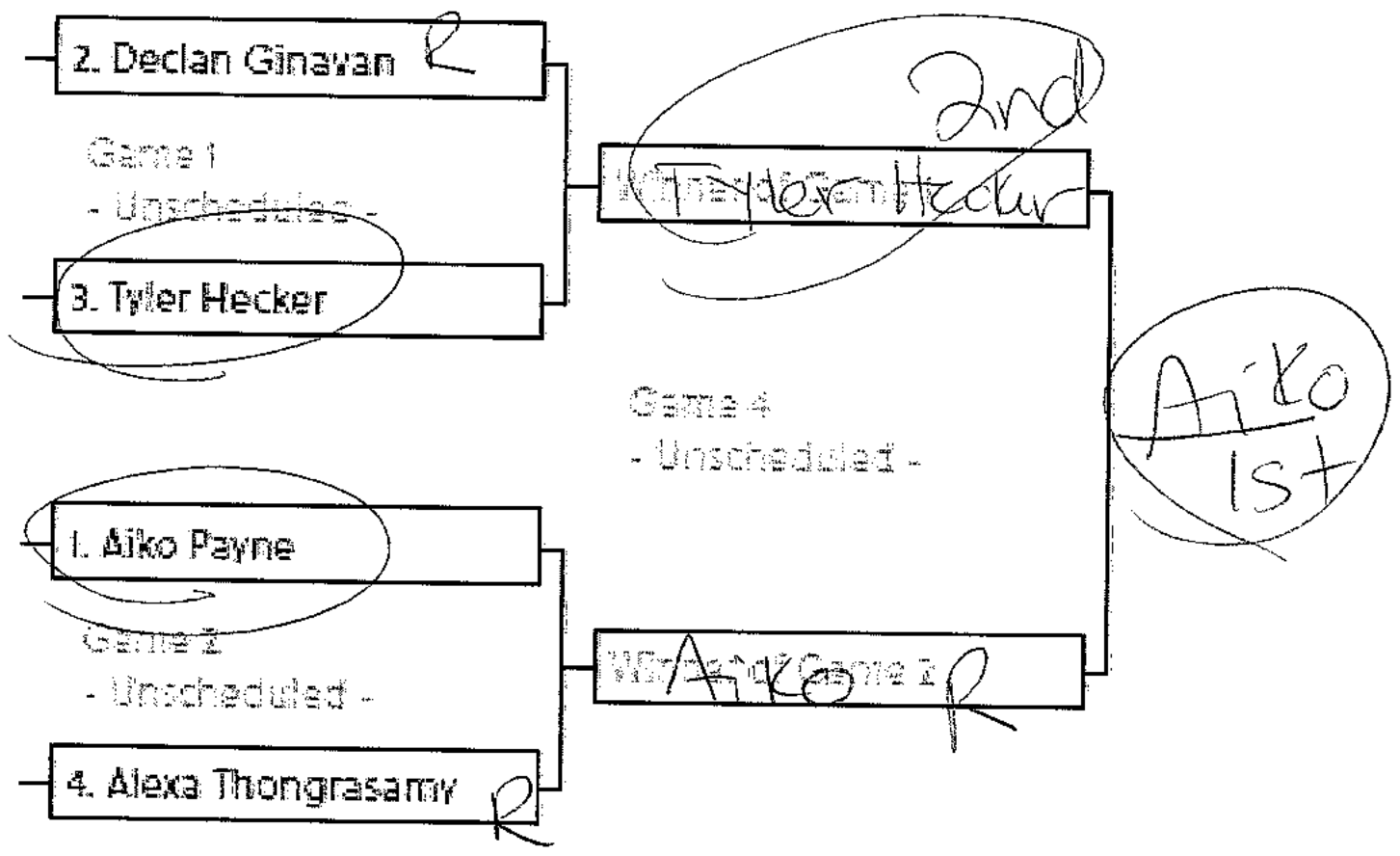

Delete Bracket

KIDS M/F - NOGI INT- 9 - 60-69

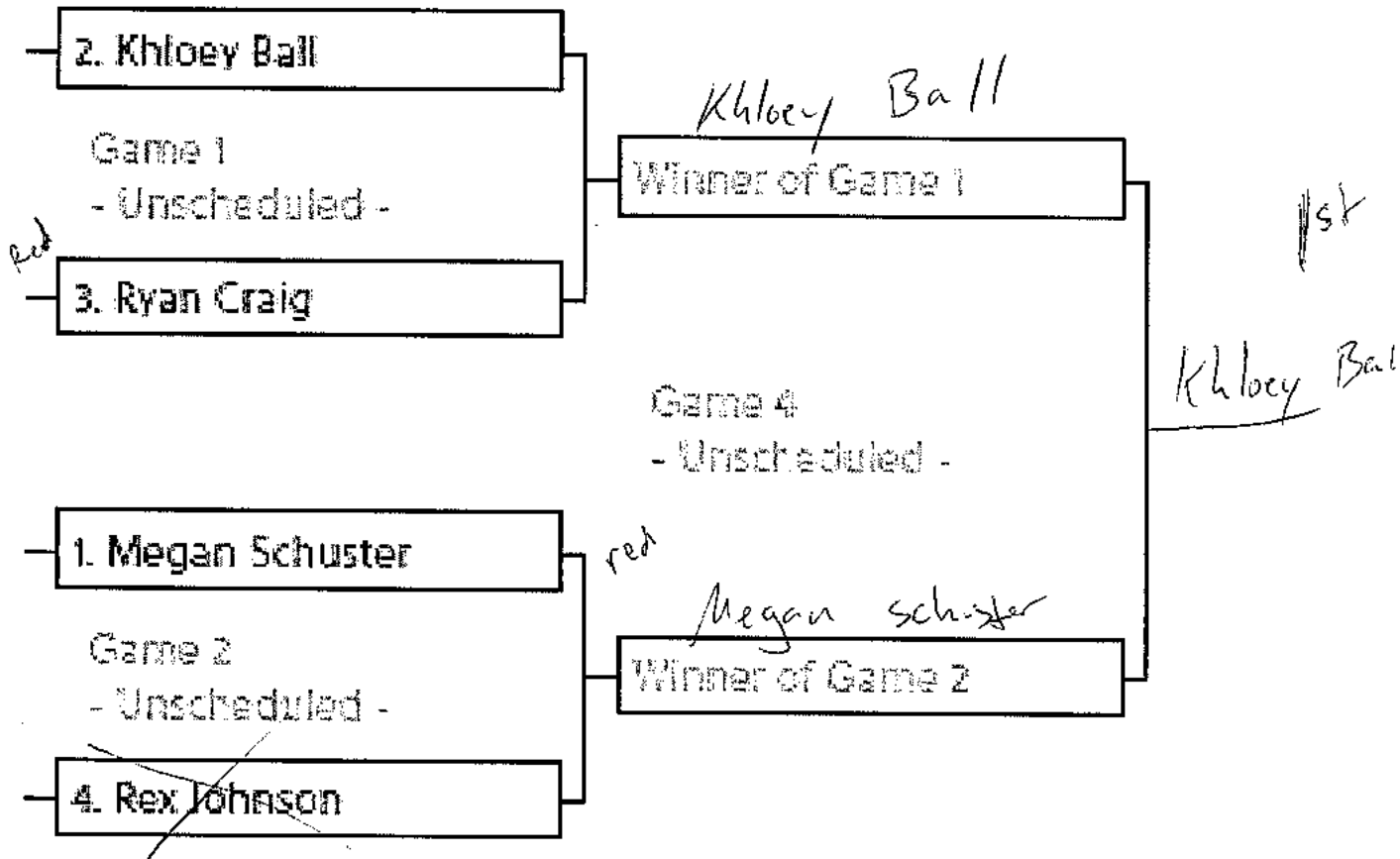

red Ryan Craig
 red Megan Schuster
 3rd
 Ryan Craig
 2nd



3

KIDS MALE - GI - WHITE/GRAY BELT - 7 & UNDER - 41-50 LBS

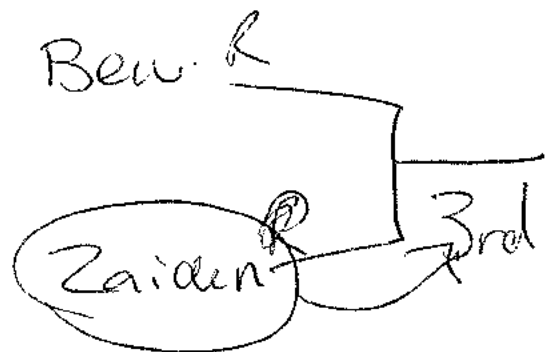
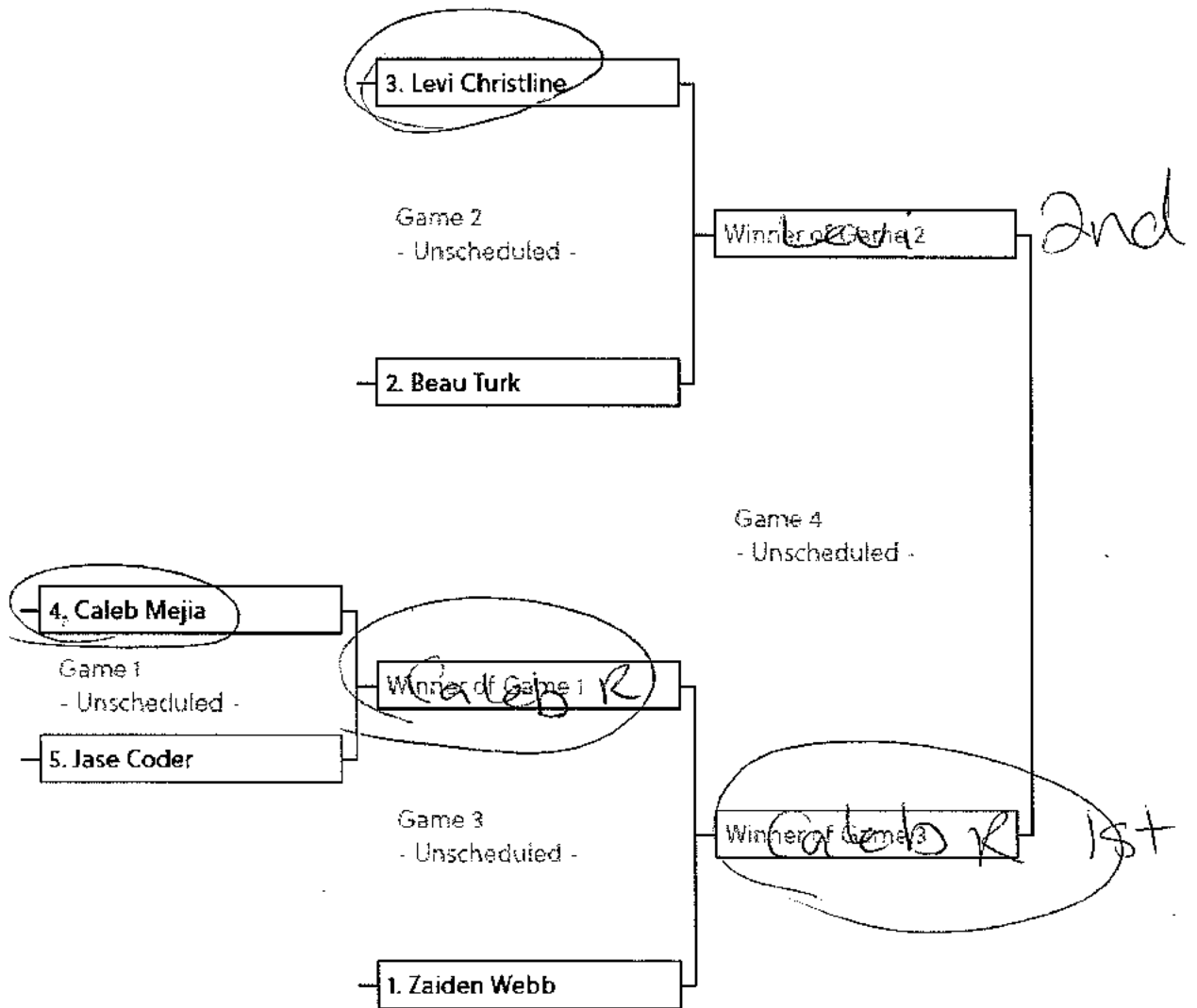

KIDS MALE - GI - WHITE BELT - 7 & UNDER - 50-59 LBS

- 1st Tyler
- 2nd Michael
- 3rd Declan

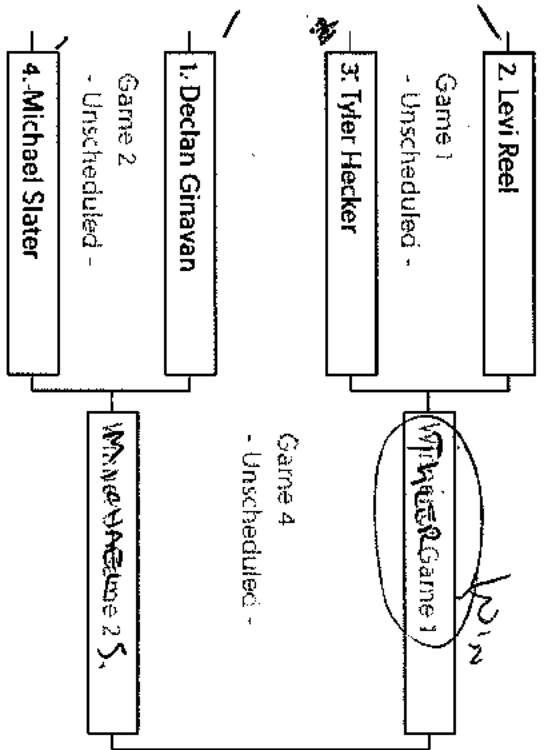

3rd Declan

LEVI

KIDS MALE - GI - WHITE BELT - 7-9 Y/O - 60-69 LBS

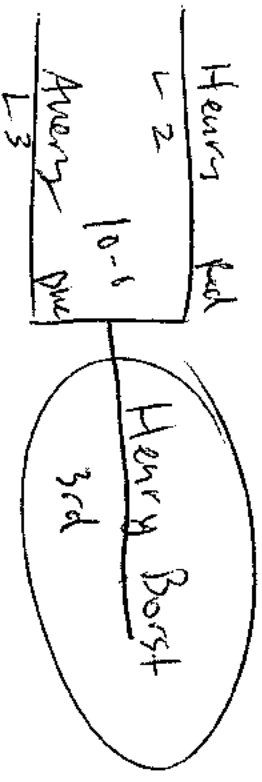
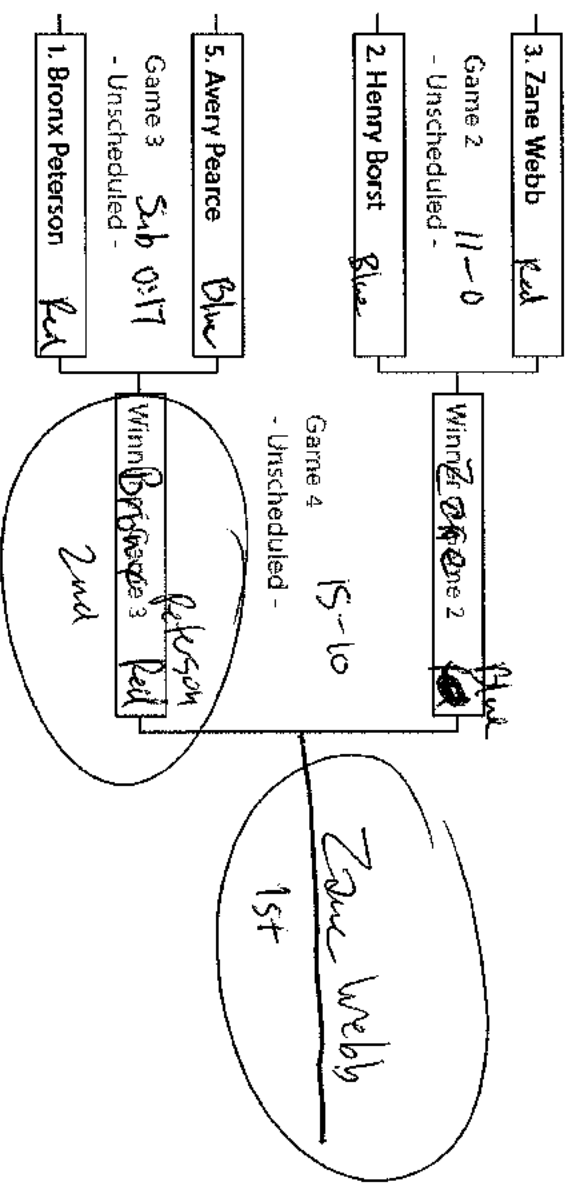

2

KIDS MALE - GI - GRAY BELT - 8-10 Y/O - 55-69 LBS

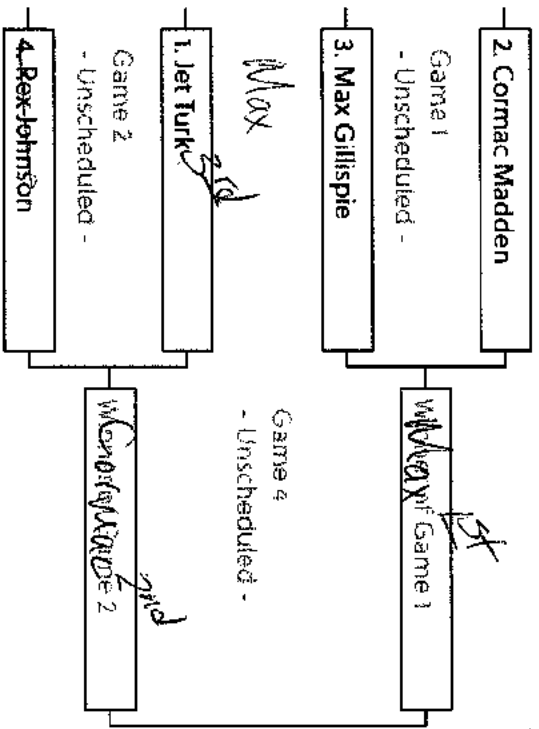

3

KIDS MALE - GI - WHITE/GRAY BELT - 8-10 Y/O - 71-85 LBS

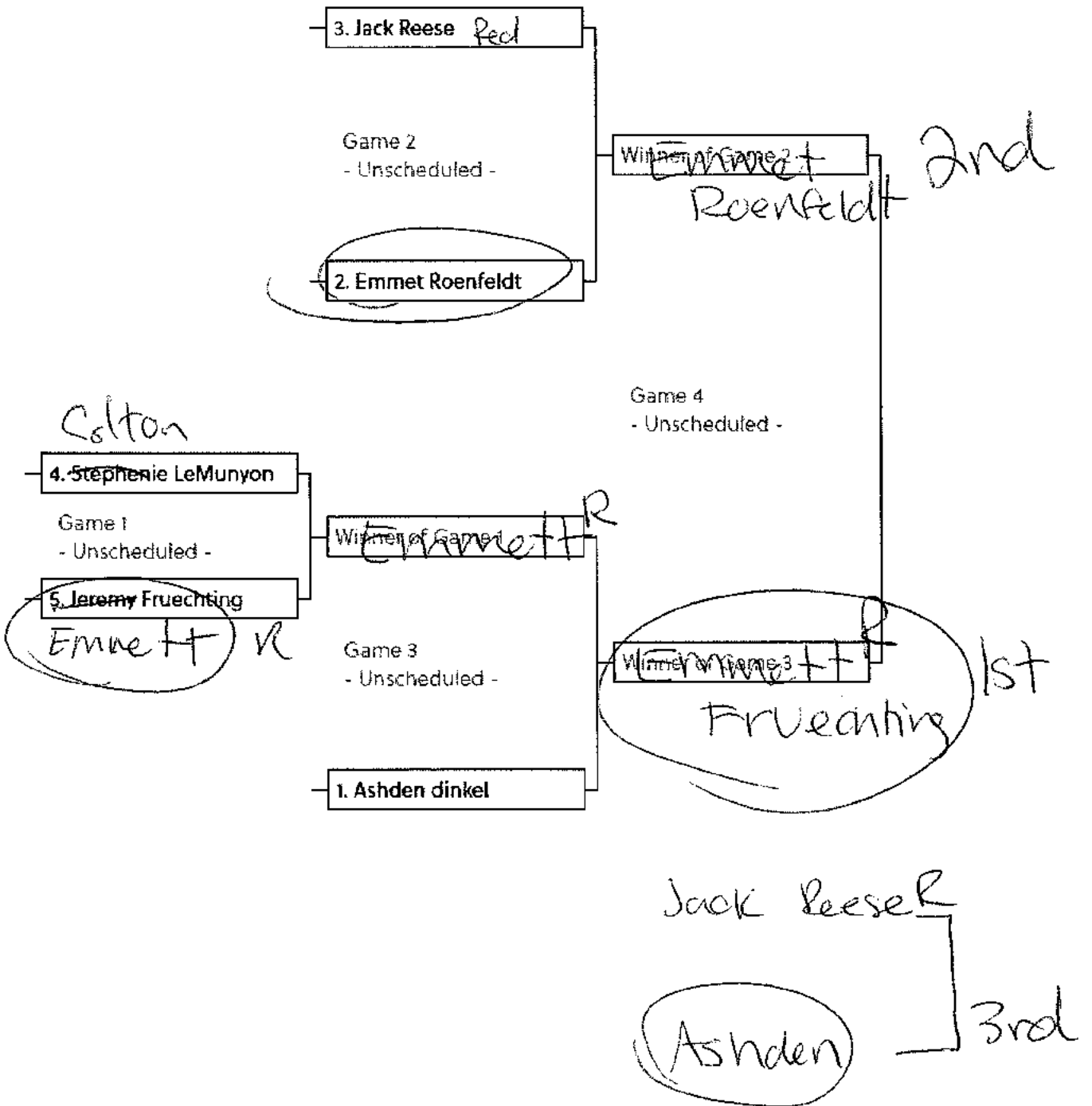

4th Grant

2nd Colvin

3rd Jacob J

KIDS MALE - GI - YELLOW/ORANGE BELT - 10-12 Y/O - 70-90 LBS

②

Jacob T.

Jacob ②

Jacob Game 3

Luke

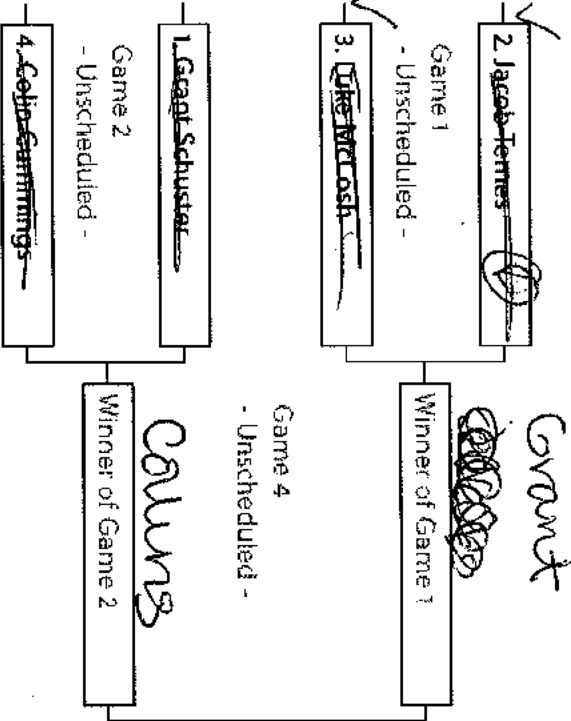

Grant S.

Luke

Colvin ②

KIDS MALE - G1 - GRAY/YELLOW/ORANGE BELT - 13-15 Y/O - 142-154 LBS

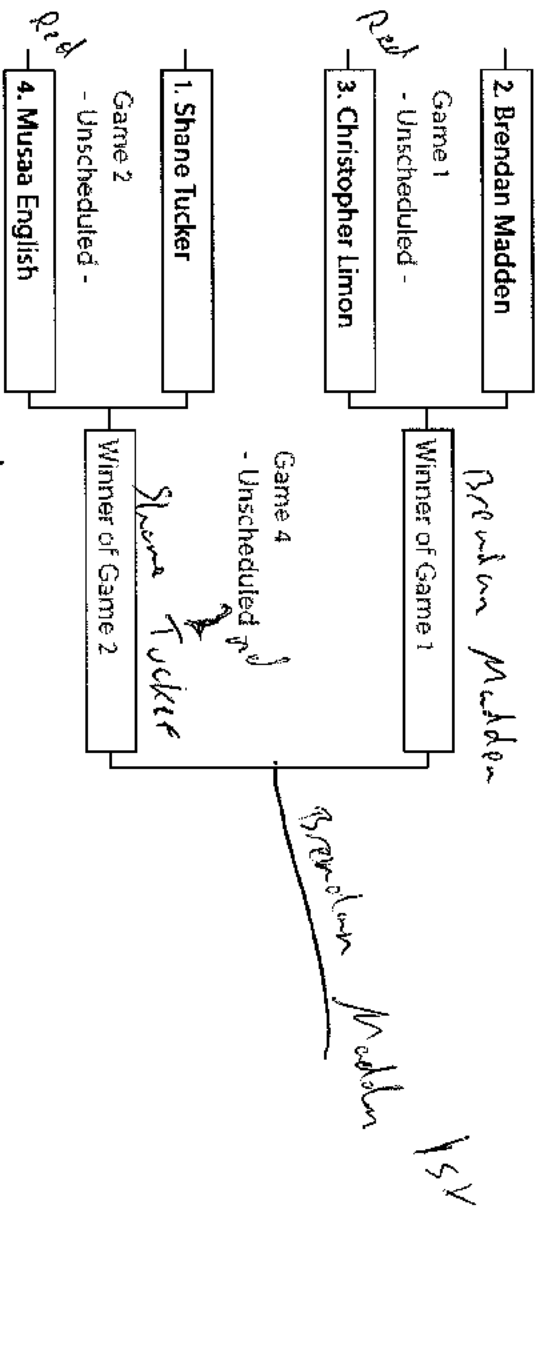

Red Christopher Limon
 Musaa English
 Christopher Limon 3rd

KIDS MALE - G1 - WHITE BELT - 13-18 Y/O - 155-167 LBS

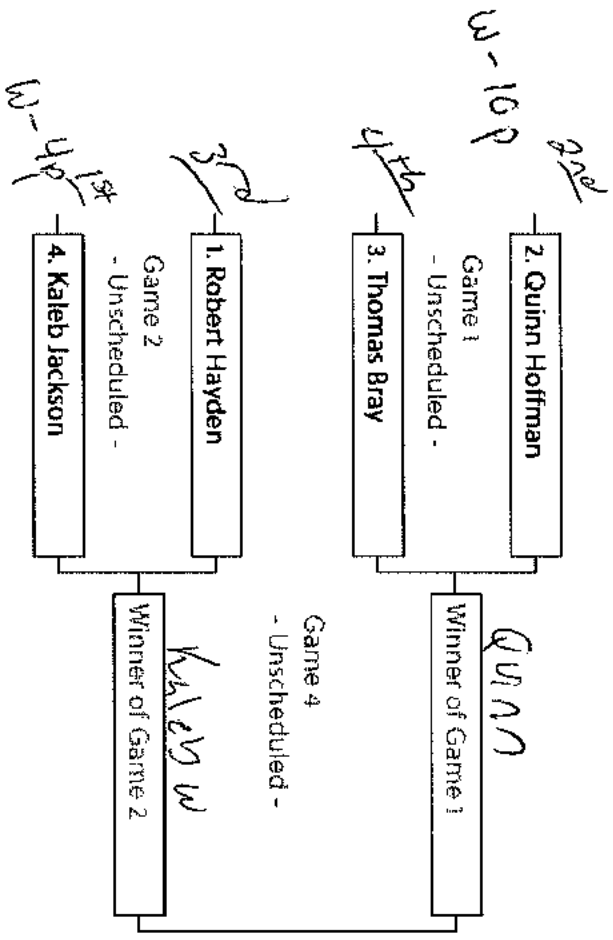

KIDS MALE - GI - WHITE BELT - 16-18 Y/O - 140-154 LBS

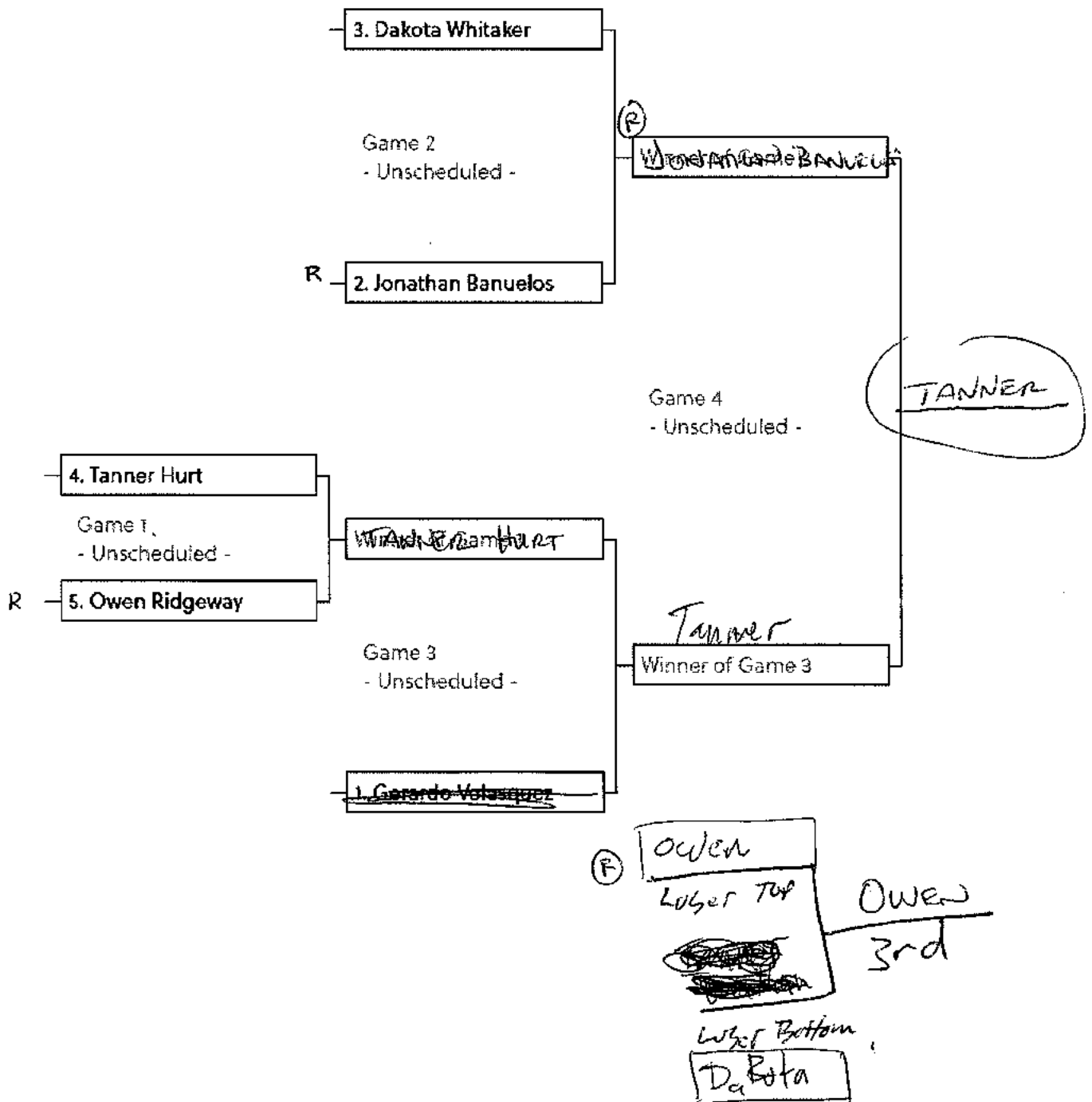

KIDS MALE - G1 - YELLOW BELT - 16-18 Y/O

2nd

1. Drevin Tucker

Game 4
- Unscheduled -

1st

2. ~~Jacob~~ Jackson

W - 2 points

0

KIDS MALE - GI - WHITE/GRAY BELT - 11-15 Y/O - 70-90 LBS

Quinton
~~Quinton~~

Gavin

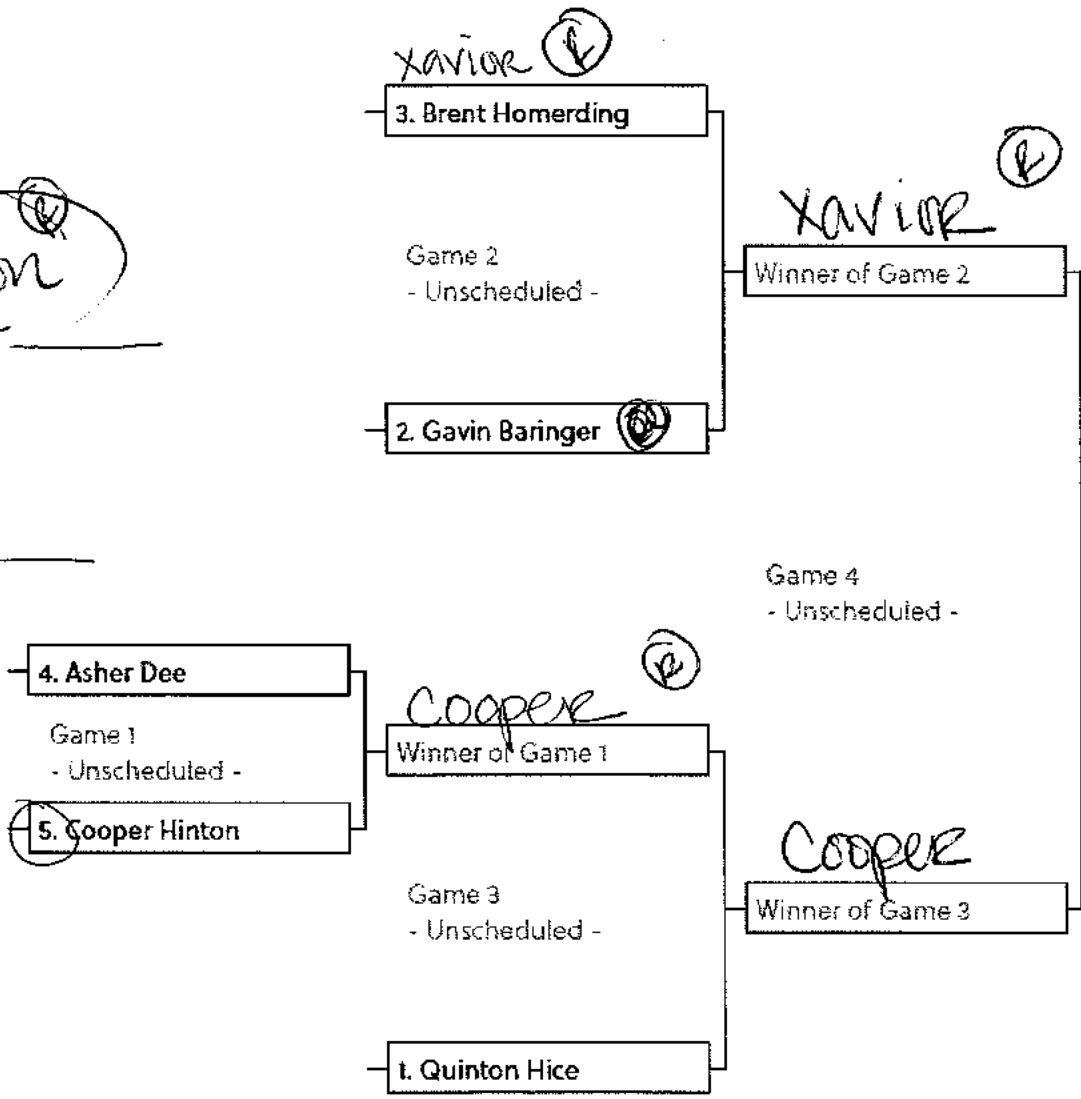

1st
COOPER

2nd
XAVIOR

3rd
Quinton

KIDS MALE - GI - YELLOW BELT - 11-15 Y/O - 100-120 LBS

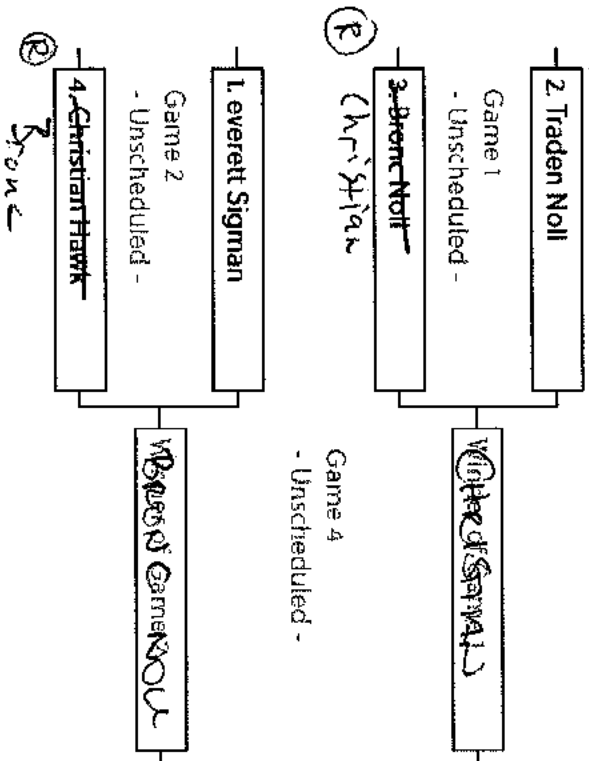

Christmas Hawk

② TRADE NOLL
LOSER TOP

② EVERETT
LOSER BOTTOM

TRADE
3rd

2

KIDS MALE - GI - WHITE/GRAY BELT - 11-15 Y/O - 115-135 LBS

1ST Camden

2ND Vann

3RD Skyleer

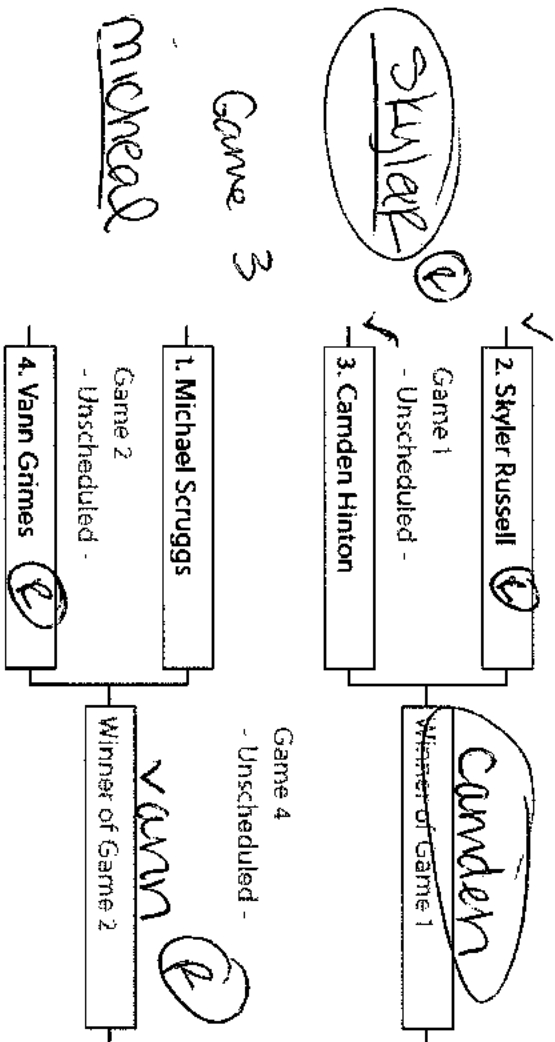

Skyleer Game 3

Michael

Skyleer

Camden

Vann

KIDS MALE - GI - GRAY/YELLOW BELT - 11-15 Y/O - 165-185 LBS

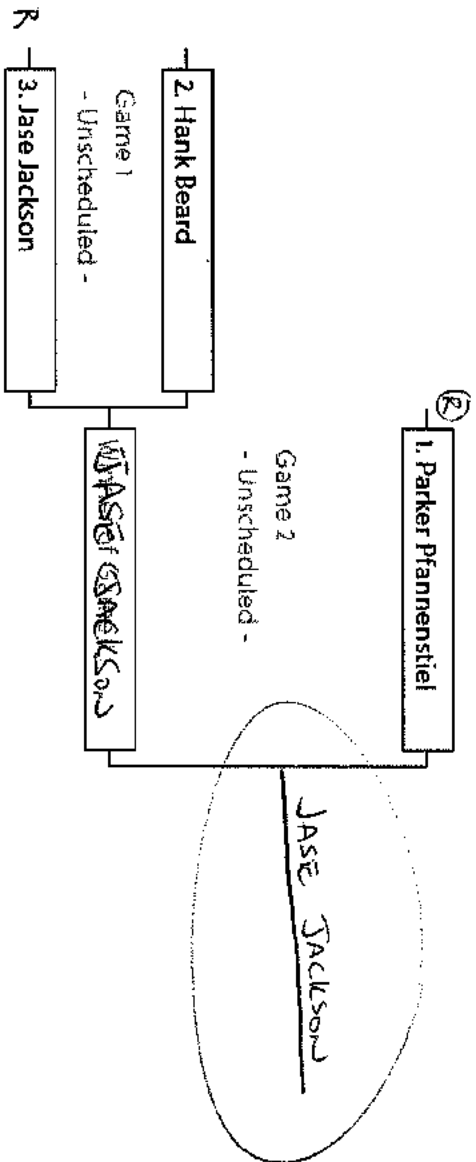

JASE JACKSON

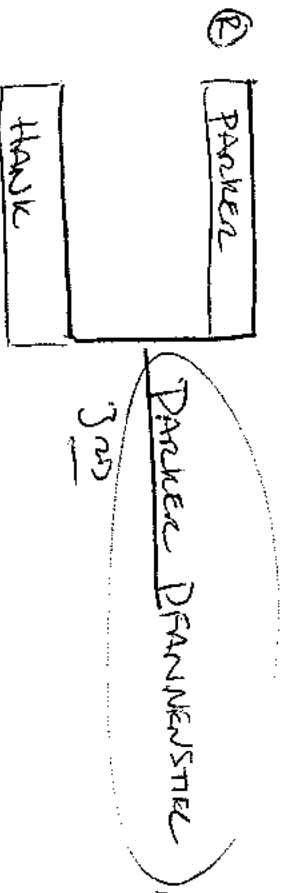

KIDS FEMALE - NOGI - 7-10 - 65-75

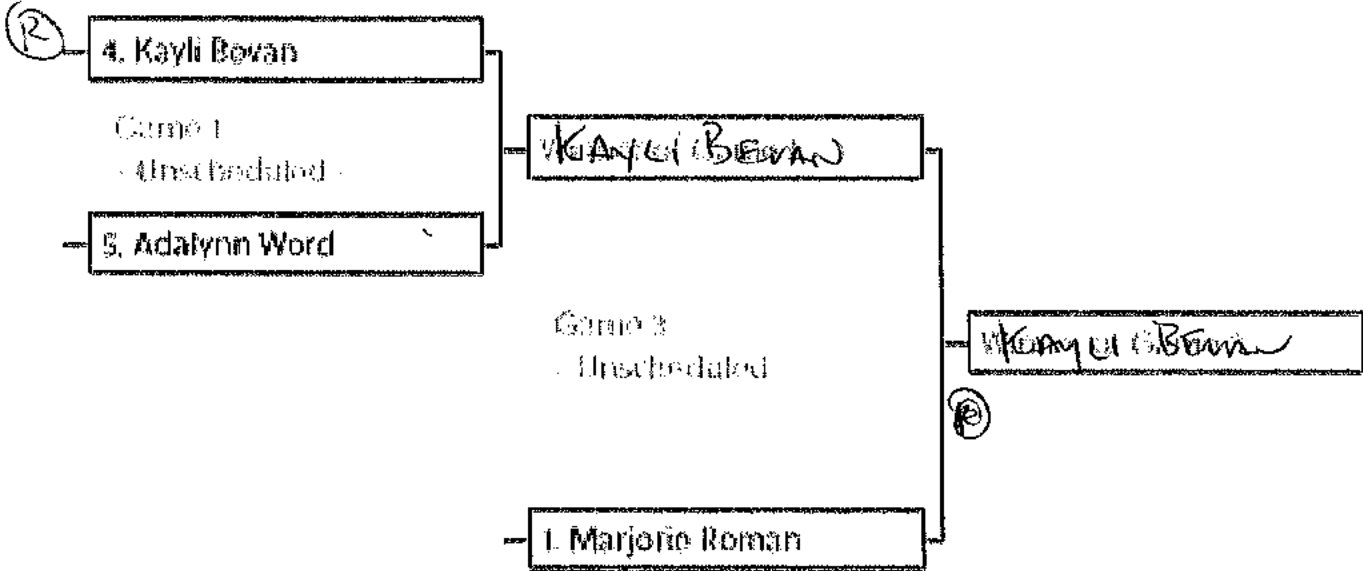
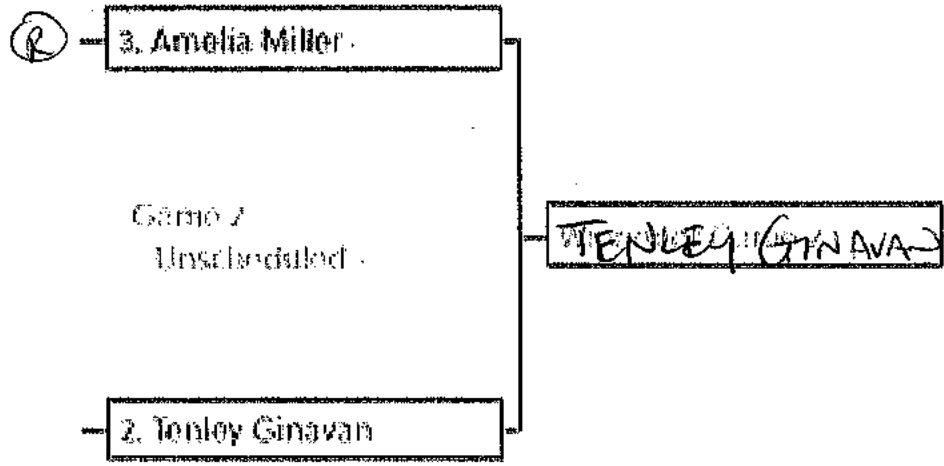

TENLEY GINAVAN

The name 'TENLEY GINAVAN' is written inside a hand-drawn circle.

| |
|---------|
| AMELIA |
| ADALYNN |

ADALYNN
3rd

A hand-drawn table with two rows and one column. The top row contains the word 'AMELIA' and the bottom row contains 'ADALYNN'. To the right of the table, the name 'ADALYNN' is written above the number '3rd'.

KIDS FEMALE - NOGI - 9-10 115-135

Best 2 of 3

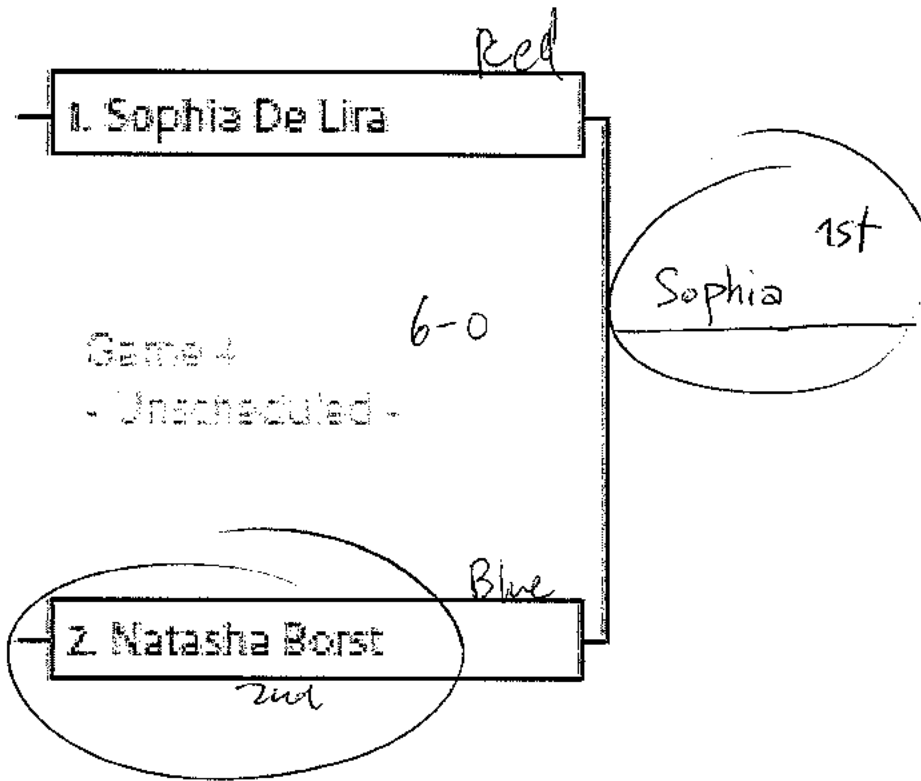

| | | |
|---------|--------|--------|
| Sophia | (Red) | Sophia |
| match 2 | 14-2 | |
| Natasha | (Blue) | |



KIDS FEMALE - NOGI - 11-12 Y/O - 95 & BELOW

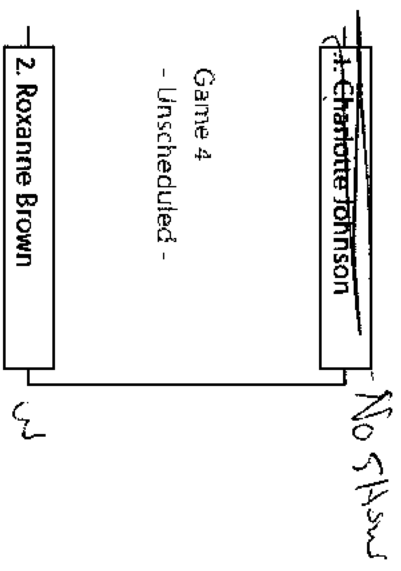

KIDS FEMALE - NOGI - 11-15 Y/O - 120-135 LBS

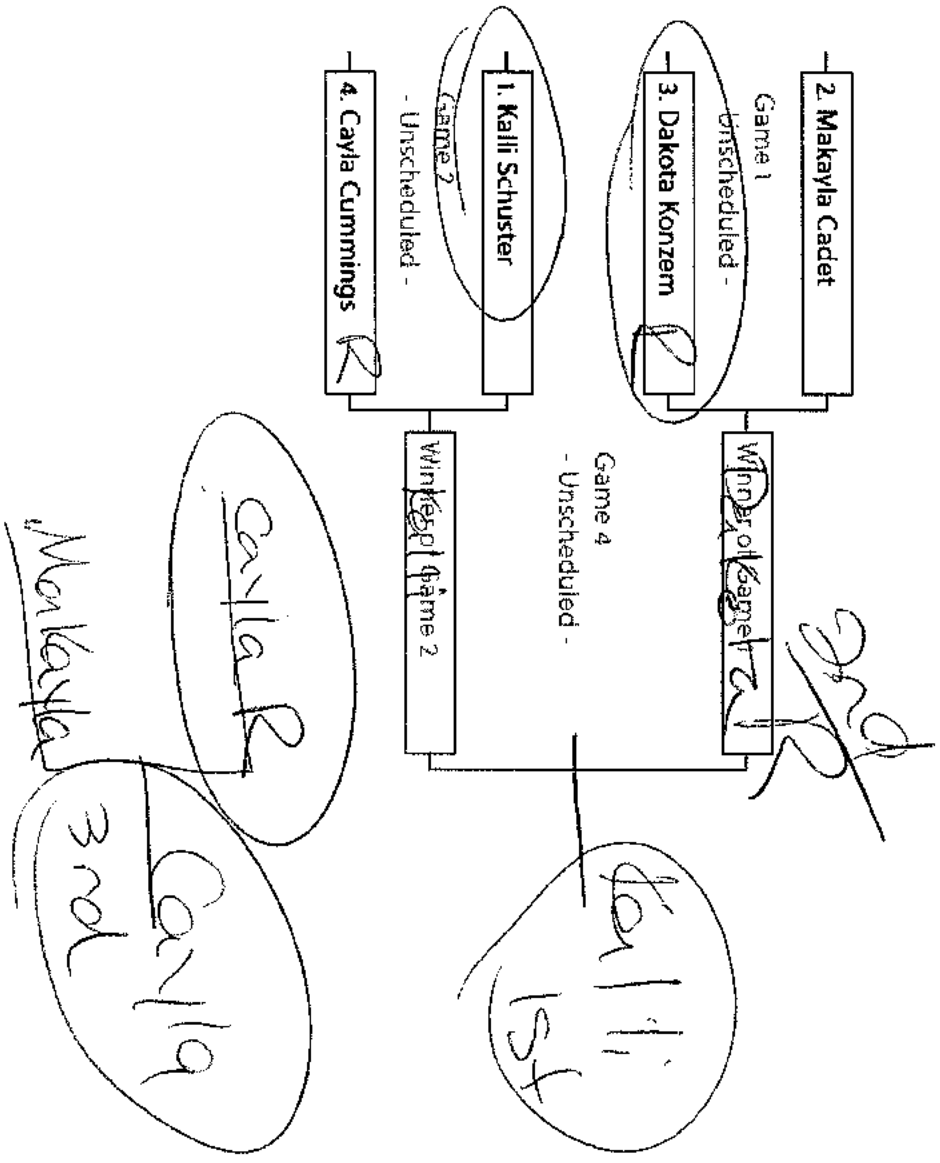

7

Sara 1st
Martha 2nd
Jordan 3rd

Sara W
Jordan

KIDS FEMALE - NOGI - 13-18 Y/O - 130-155 LBS

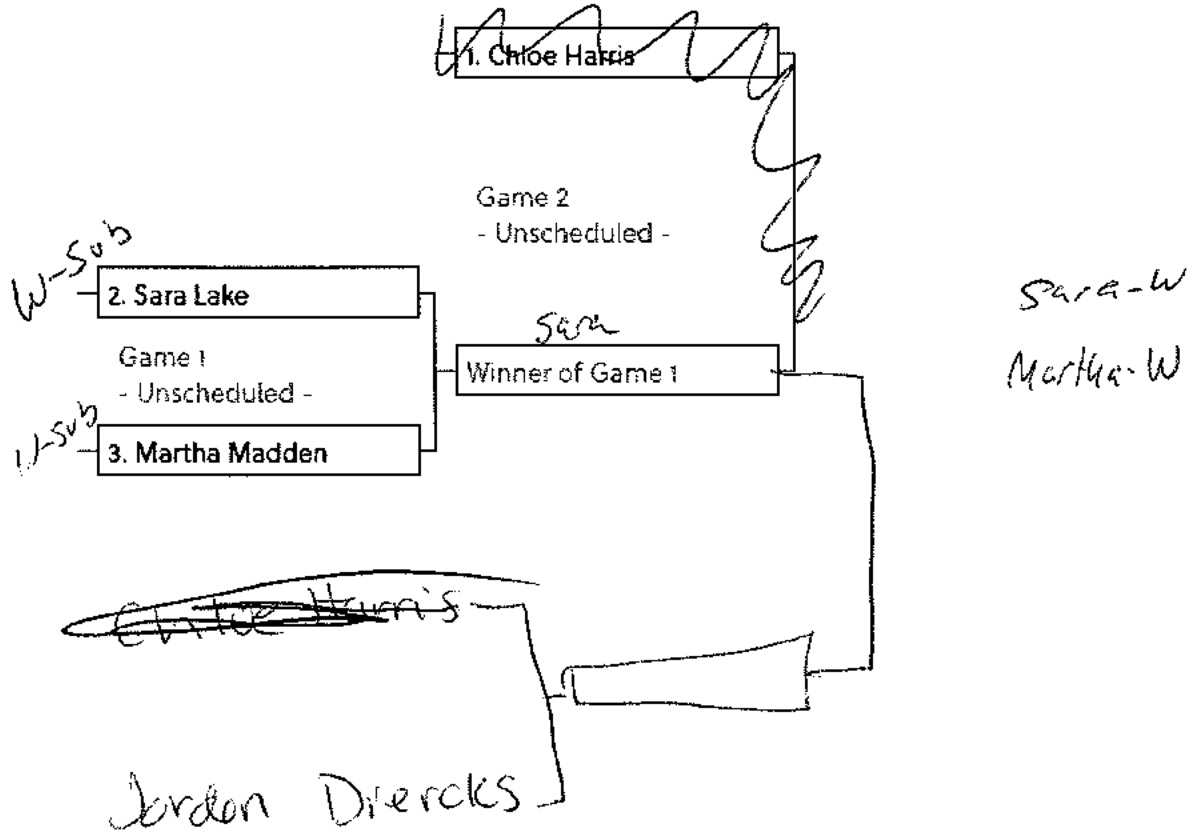

6

KIDS FEMALE - GI - WHITE/GRAY BELT - 7 & UNDER - 54 LBS & BELOW

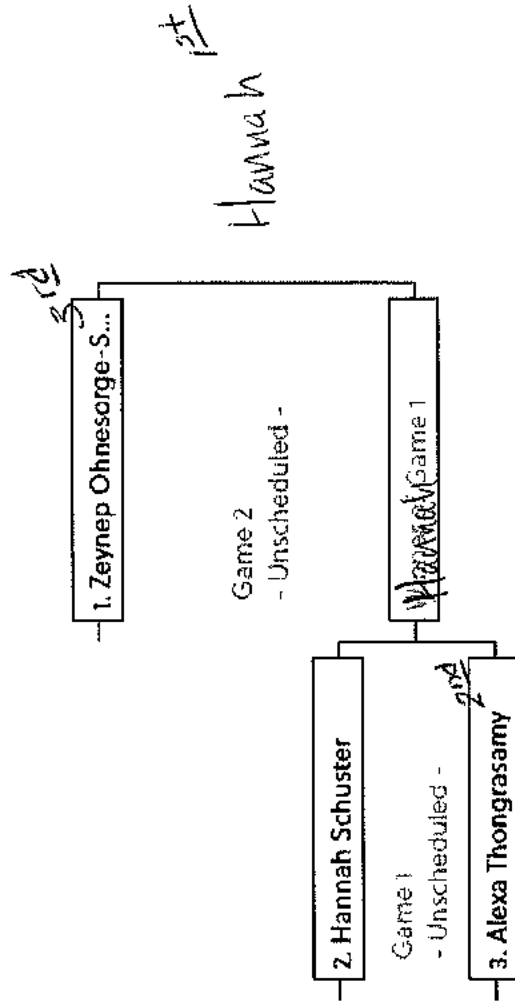

4

KIDS FEMALE - GI - GRAY BELT - 7 & UNDER - 51-70 LBS

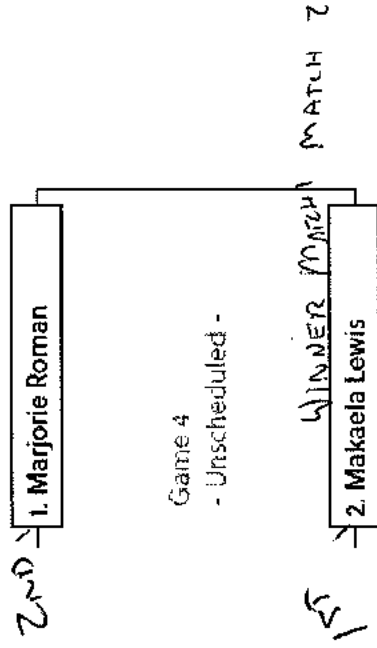

4

KIDS FEMALE - GI - GRAY BELT - 8-10 Y/O - 55 LBS & BELOW

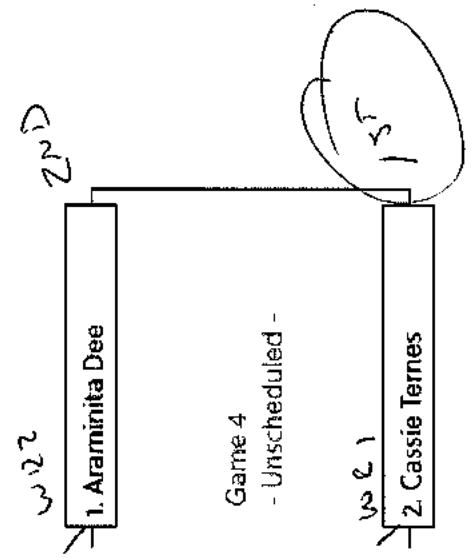

4

1ST TRINITY
2ND JULIET
3RD AIKO

KIDS FEMALE - GI - WHITE BELT - 8-10 Y/O - 56-80 LBS

2/3
Aiko
JULIET WINNER

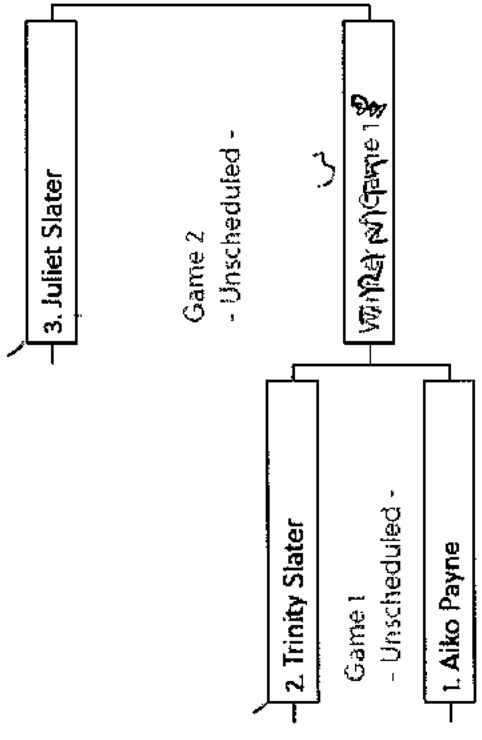

5

KIDS FEMALE - G1 - GRAY/YELLOW BELT - 8-10 Y/O - 62-72 LBS

Ronald Robin

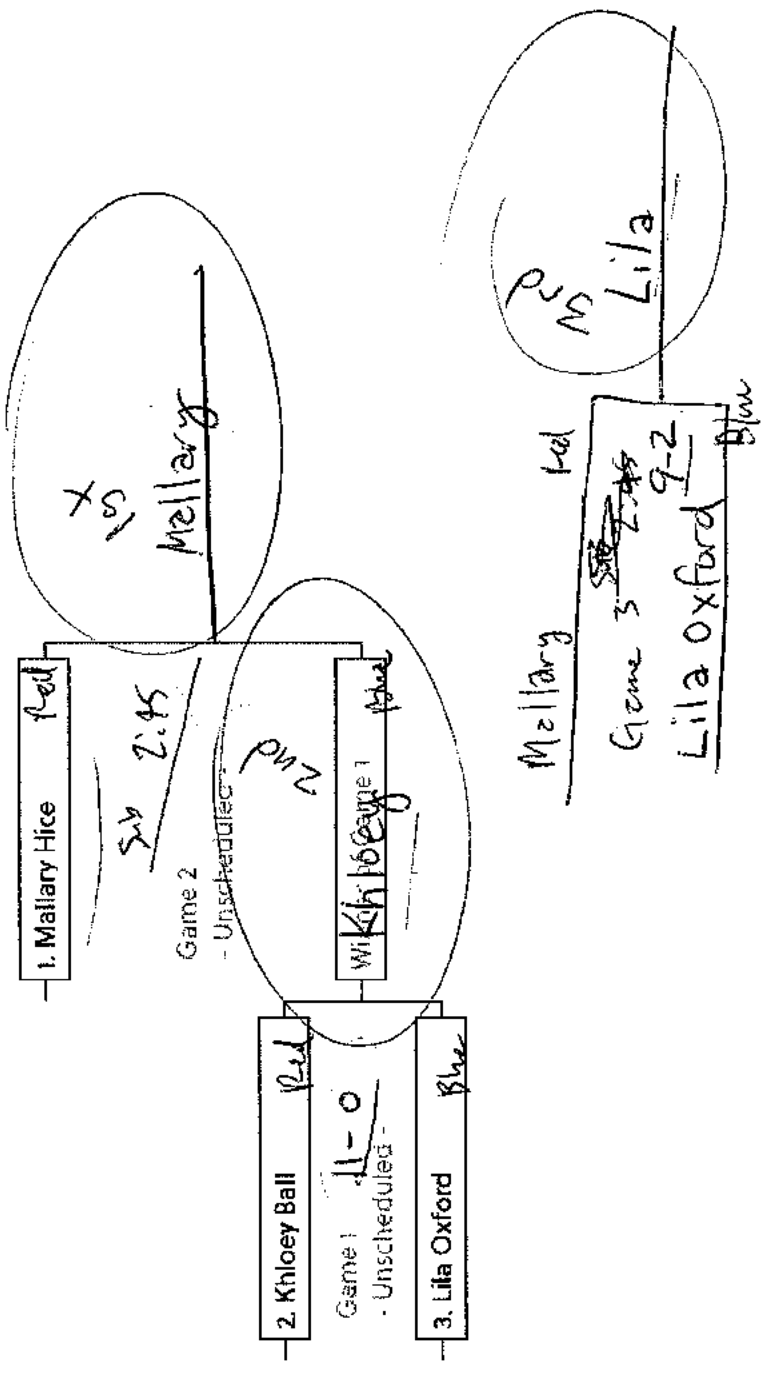

6

KIDS FEMALE - GI - GRAY BELT - 8-10 Y/O - 67-77 LBS

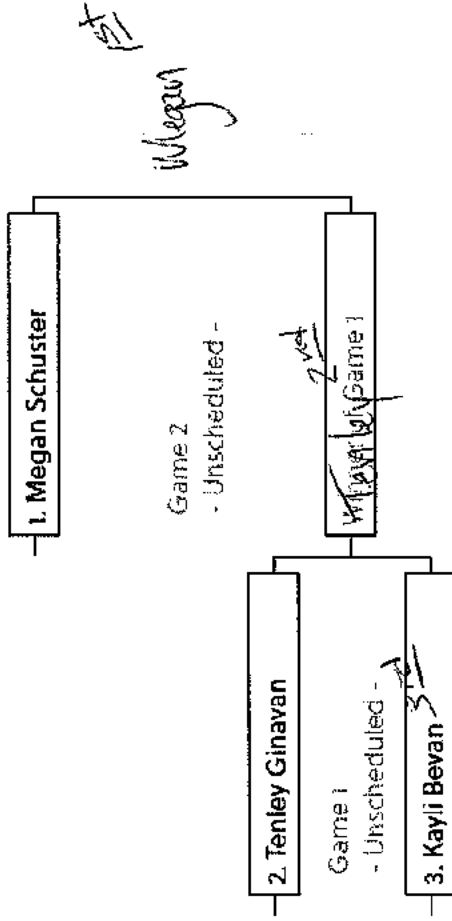

6

KIDS FEMALE - GI WHITE BELT - 8-10 Y/O - 115-135 LBS

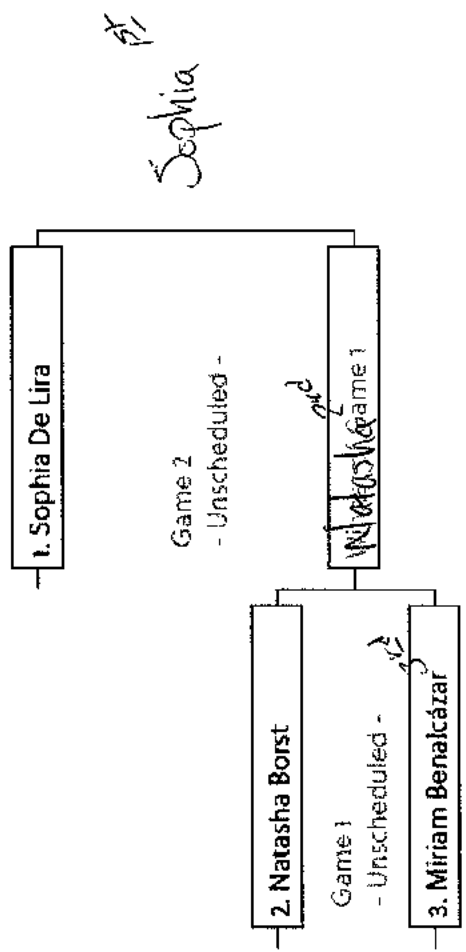

5

KIDS FEMALE - GI - GRAY BELT - 8-12 Y/O - 95-110 LBS

1st Ryan
2nd Stevie

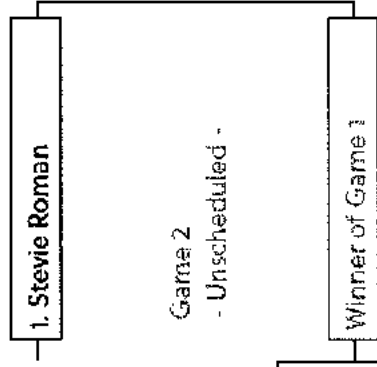

Game 2
- Unscheduled -

Winner of Game 1

2. Ryan Turk

Game 1
- Unscheduled -

3. Charlotte Johnson

No Show

Ryan Turk (Red)

Game 3
Sub O'SS

Stevie Roman (Blue)

Ryan Turk

Ryan Turk

Sub O'SS

Stevie Roman

3:00

KIDS FEMALE - GI - WHITE BELT - 11-12 Y/O - 85-100 LBS

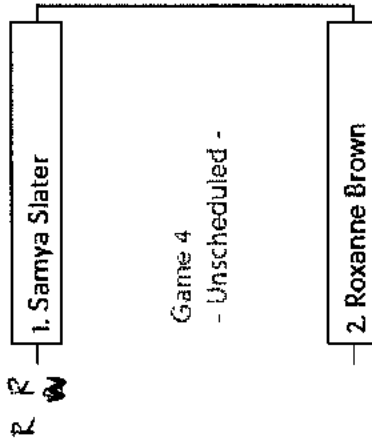

CSJ
RND 1 - Samya - 9 points
RND 2 - Samya - 3 points
RND 3 - Slater

KIDS FEMALE - GI - GRAY BELI - 11-12 Y/O - 128-141 LBS

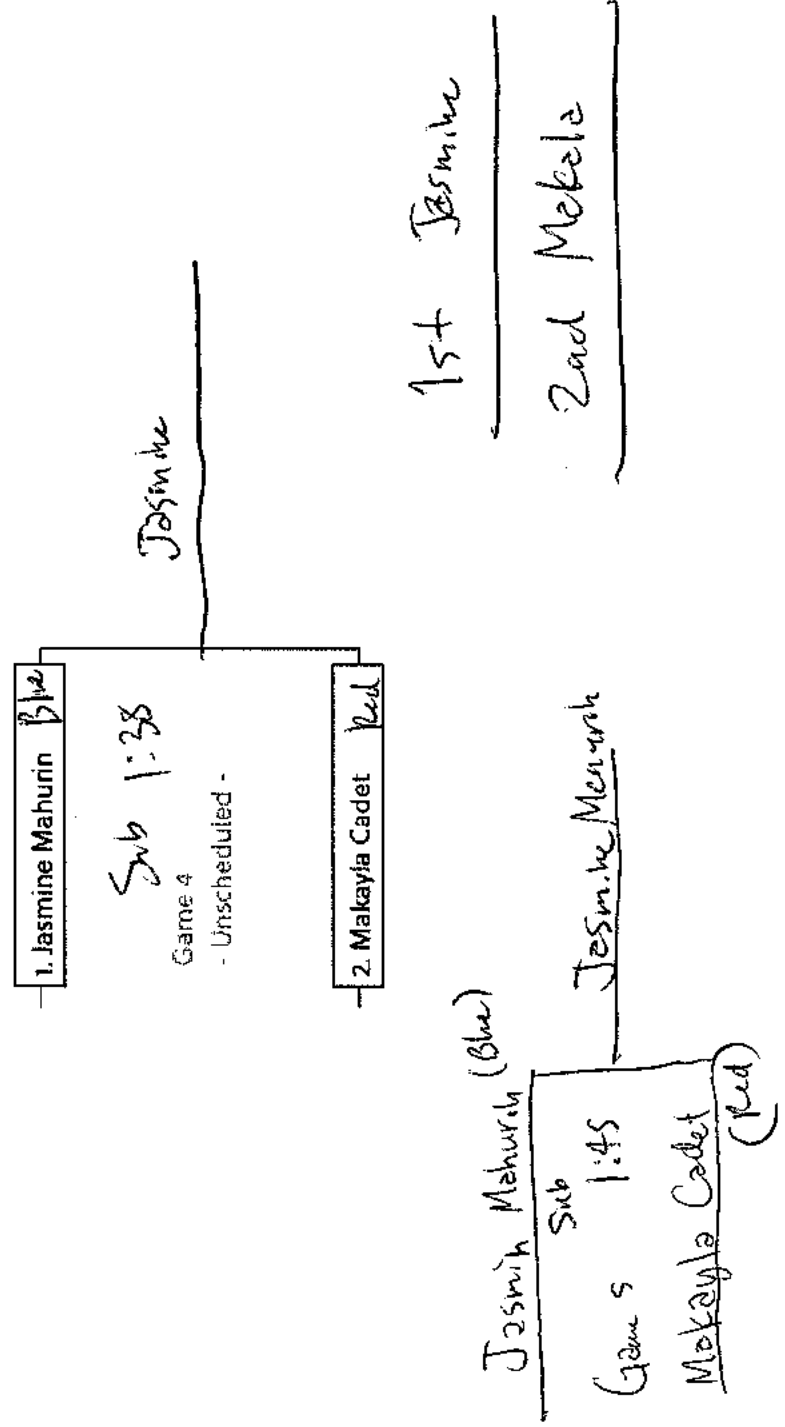

Best 2 of 3



2

KIDS FEMALE - GI - GRAY/YELLOW BELT - 13-15 Y/O - 120-129 LBS
~~Best of 3~~ Best 2 out of 3

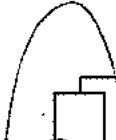
Kalli 

1. Kalli Schuster 

Kalli

Game 4
- Unscheduled -

2. Dakota Konzern

Dakota

Dakota

1st Kalli

2nd Dakota

8

KIDS FEMALE - GI - GRAY/YELLOW BELT - 13-15 Y/O - 90-99 LBS

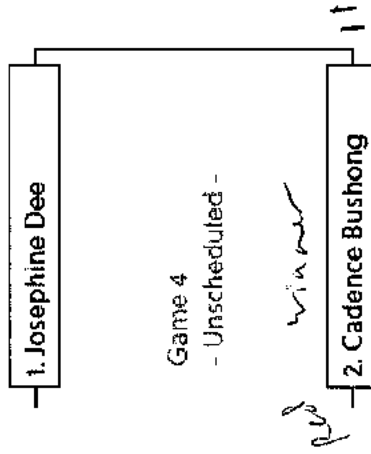

7

KIDS FEMALE - GI - GRAY/YELLOW BELT - 13-15 Y/O - 130-139 LBS

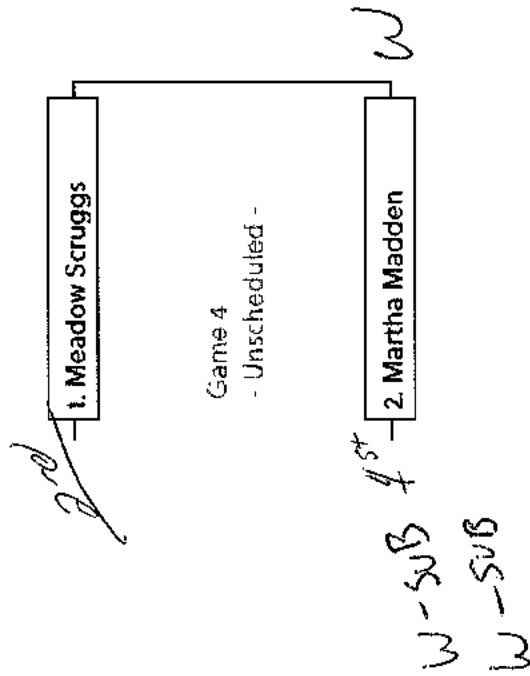

8

KIDS FEMALE - GI - WHITE BELT - 13-18 Y/O - 90-115 LBS

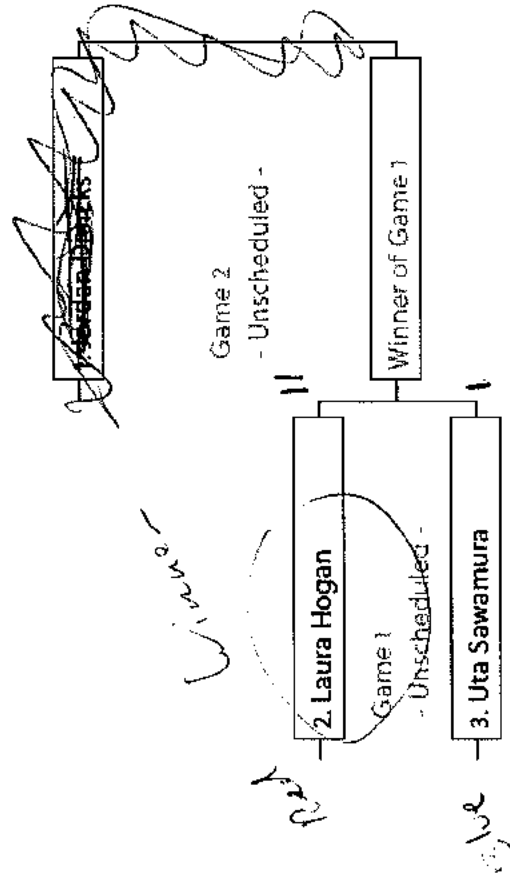

8

KIDS FEMALE - GI - WHITE BELT - 13-18 Y/O - 120-140 LBS

Jordan Dirreks

~~Bri~~ Bri

1. Bri Anderson

Bri Anderson

Game 4
- Unscheduled -

2. Cayla Cummings

Red Jordan
Cayla Cummings
Jordan F

7

KIDS FEMALE - GI - ORANGE/GREEN BELT - 13-18 Y/O - 142-154 LBS

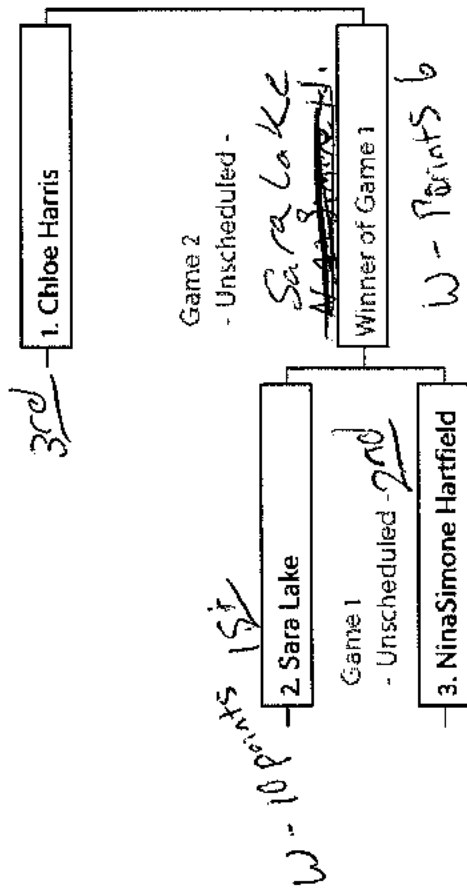

9

FEMALE - NOGI INTERMEDIATE - 100-130 LBS

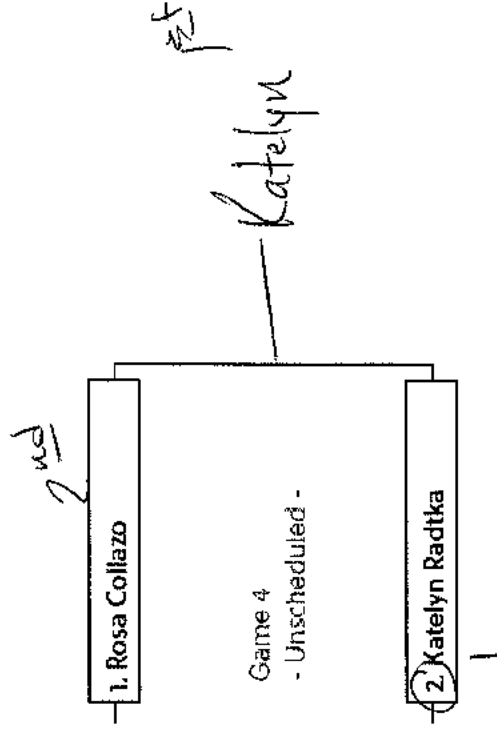

FEMALE - GI - WHITE BELT - 100-130 LBS

6

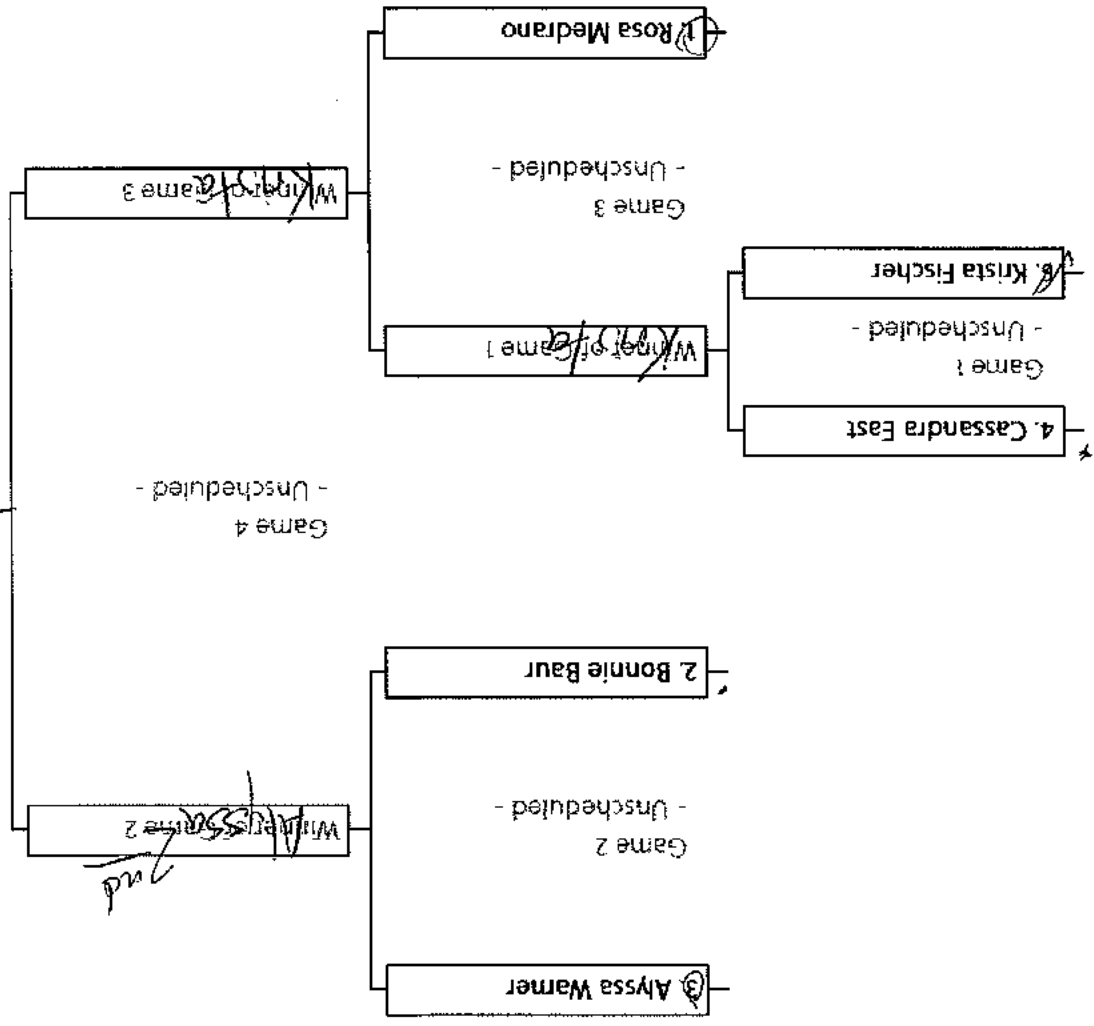
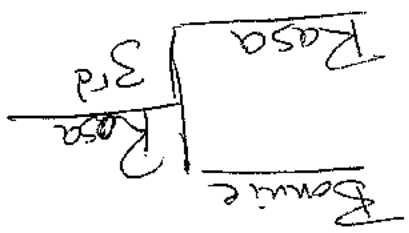

Krista
1st

Winner of Game 2
Alyssa Warner
2nd

M

FEMALE - NOGI BEGINNER - 121-127 LBS

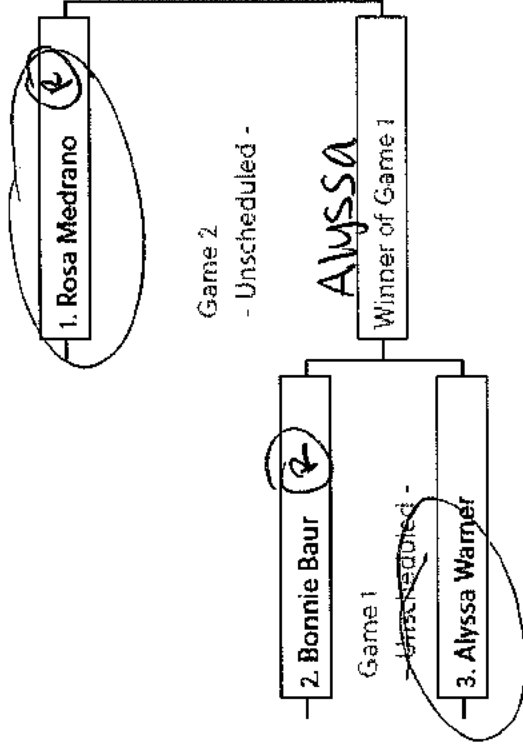

Rosa

Bonnie

1st ROSA 2nd Alyssa 3rd Bonnie

4

FEMALE - NOGI BEGINNER - 128-141 LBS

CASS -
Rhiana - WGP
~~Rhiana~~

Rhiana SF
Cassandra JMD

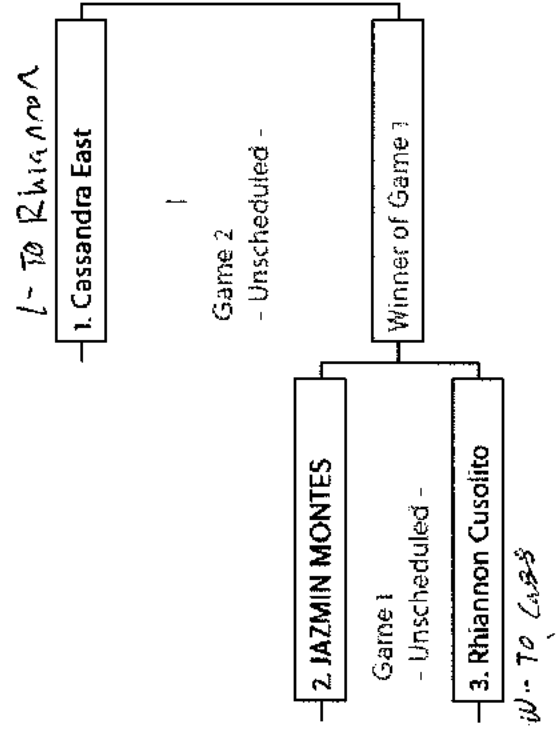

1- To Rhiana

1. Cassandra East

1

Game 2
- Unscheduled -

2. JAZMIN MONTES

Game 1
- Unscheduled -

3. Rhannon Cusolito

W. To Cass

Winner of Game 1

Winner of Game 2

C

FEMALE - GI - BLUE BELT - 100-140 LBS

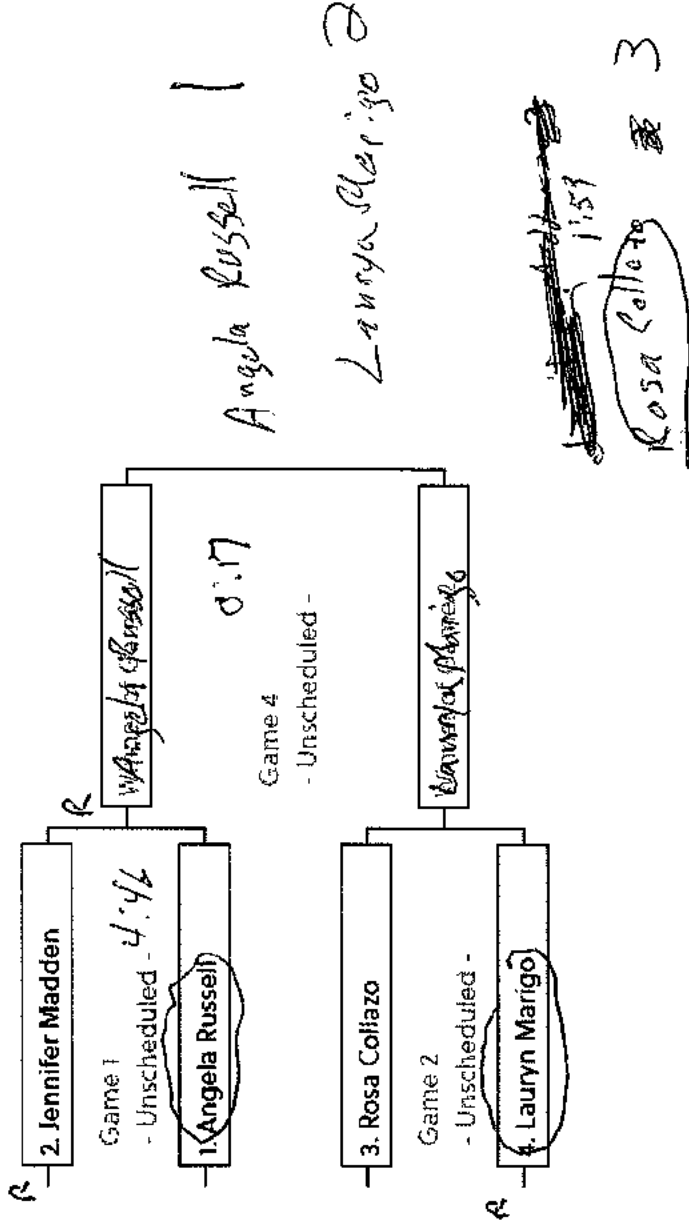

FEMALE - GI - WHITE BELT - 131-160 LBS

Smns

4

1st - 2nd

1st

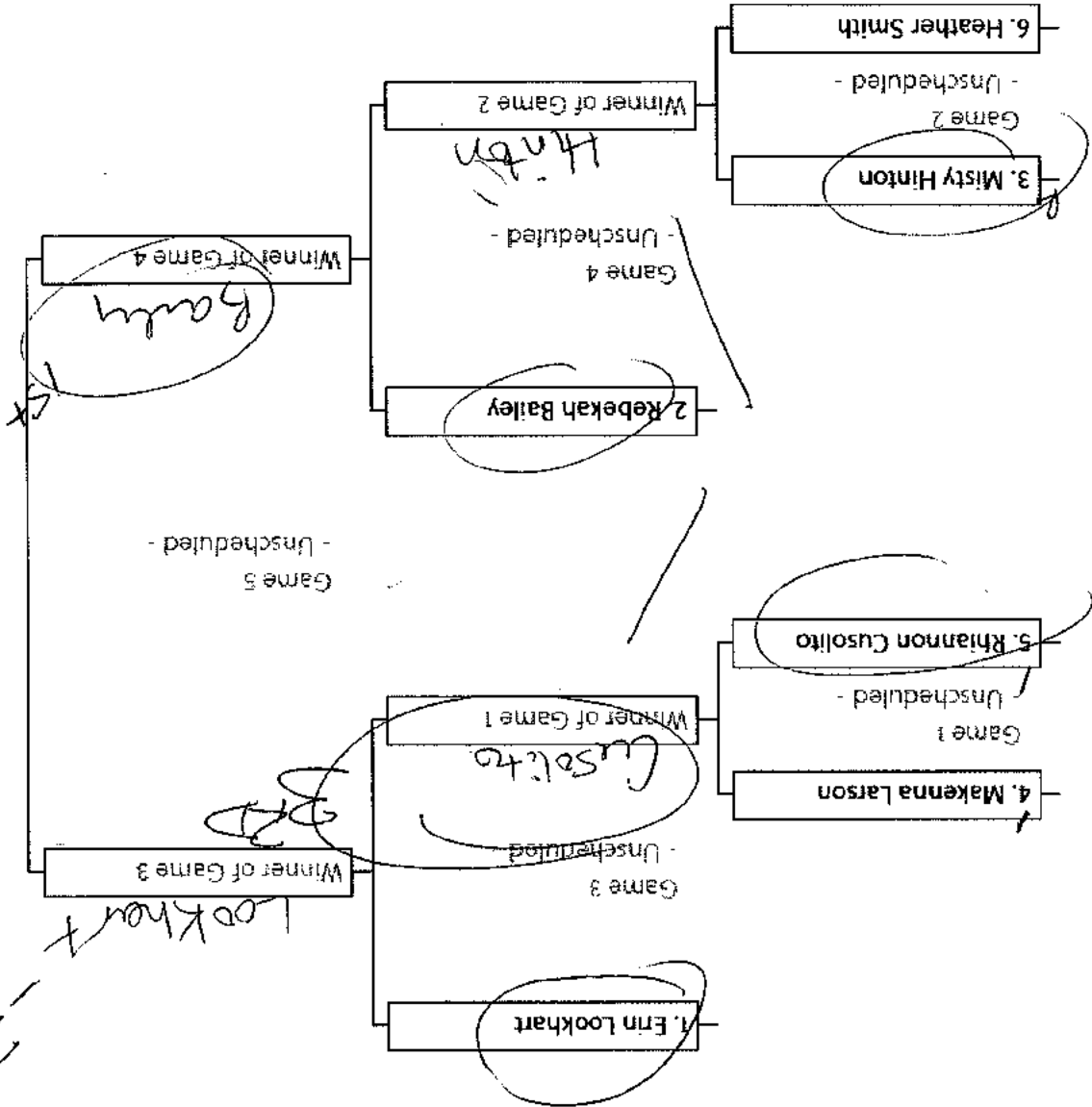

6m

FEMALE - GI - BLUE BELT - 141-160 LBS

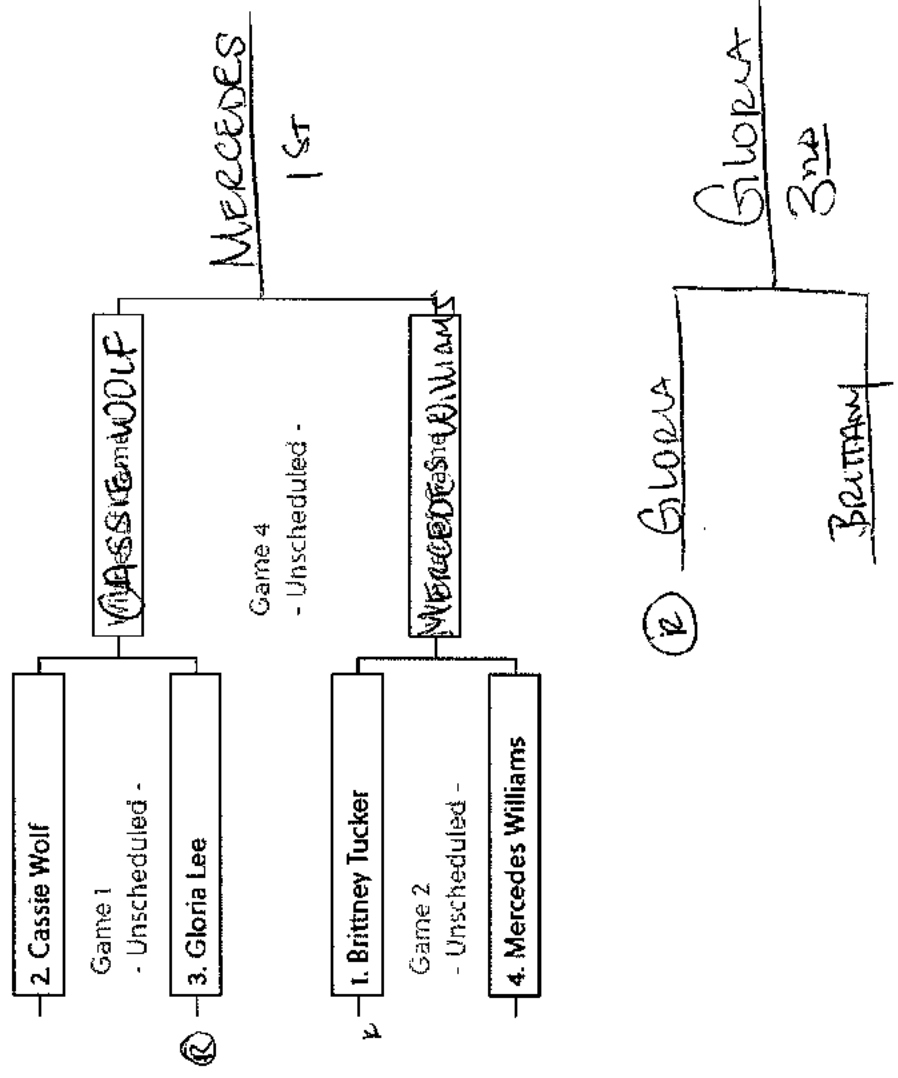

⑫ Gloria

Gloria
Brittney

6m

FEMALE - GI - WHITE BELT - 160+ LBS

Round 1: TRACY
Round 2: SARATT
Round 3: →

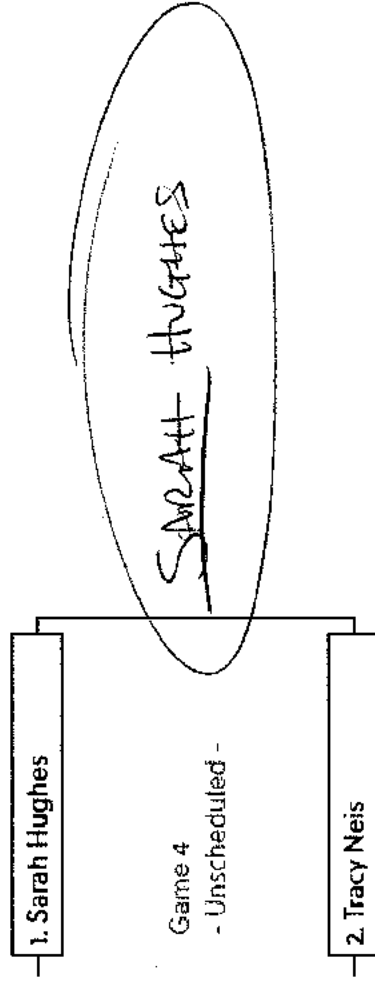

g

FEMALE - NOGI BEGINNER - 145-160 LBS

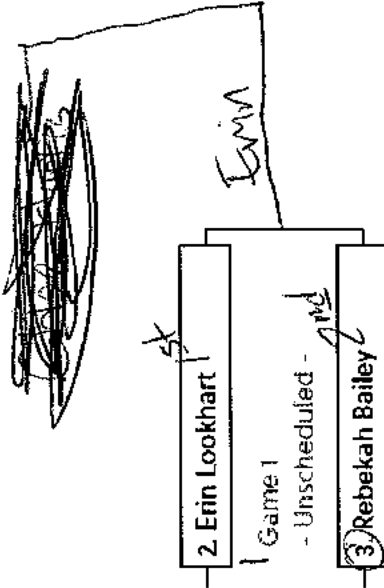

- 2 Erin Lookhart
- Game 1
- Unscheduled -
- 3 Rebekah Bailey

5

6 min

FEMALE - NOGI INTERMEDIATE - 131-170 LBS

Round Robin

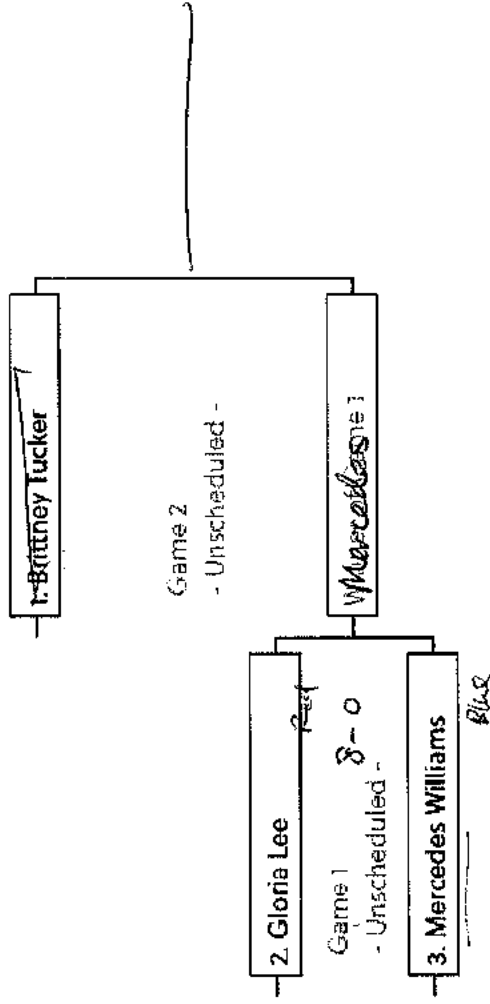

L

FEMALE - NOGI BEGINNER - 161+ LBS

ST

wid

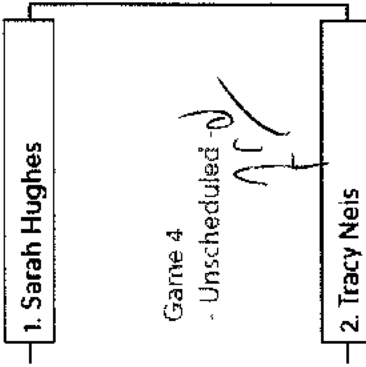

FEMALE - NOGI INTERMEDIATE - 171+ LBS

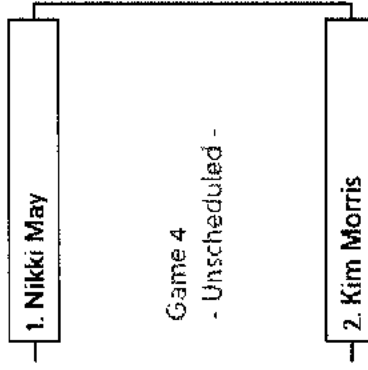

w w

7

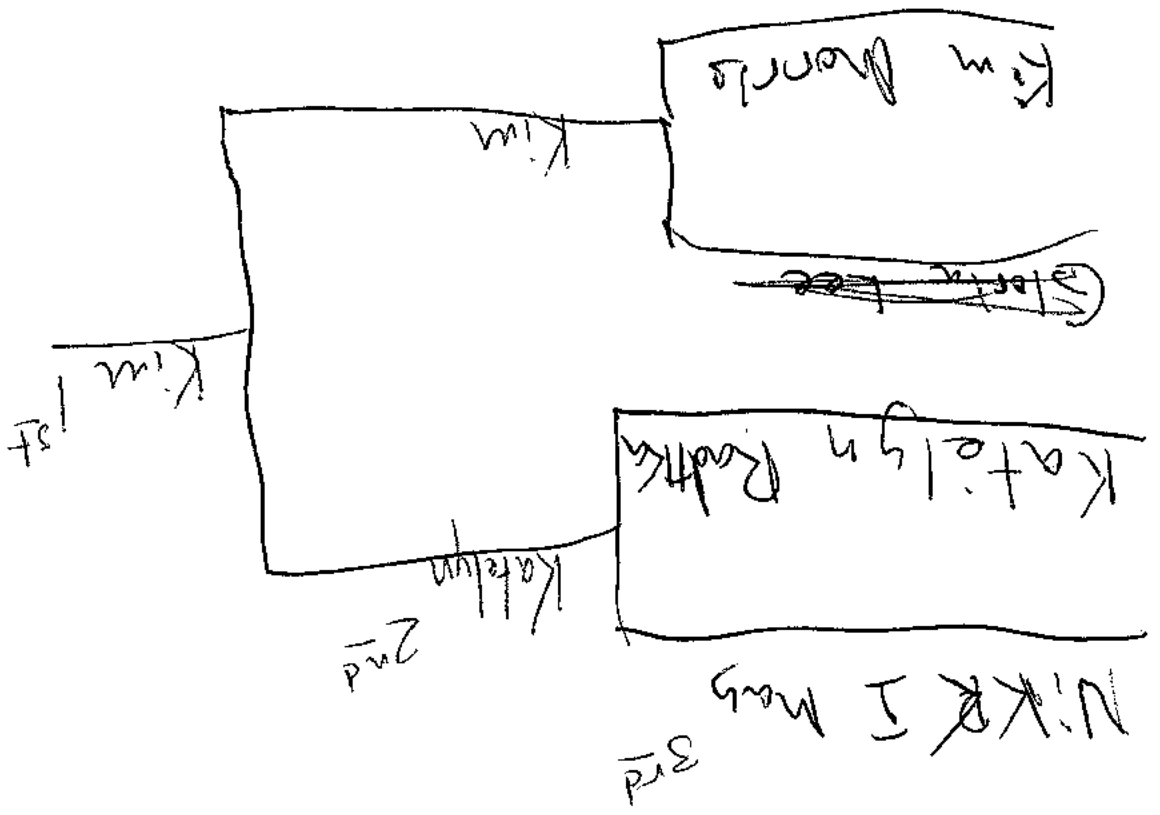

Team
RIVERS
Luscha
STBJ
CSC

Above
NIKKI MAY
Gloria Lee
Katelyn Radtka
Kimmonds

Female Boss! Int Absolute

Female Negi Beg Abschute

Name

Erin Leckert

Sarah Hughes
Rhannon Casalta

Rhannon Casalta

Crigo

Ca Selva

STRTS

Team

Rhannon

Erin Leckert 2

Sarah Hughes 3

Rhannon Casalta

3:48

2 Sarah Hughes

Rhannon Casalta

Female Blue Purple Absolute X75

Name
MAY
GLORIA LEE
KIM MORIS

Team
RIVERS
Luisdun
ASC

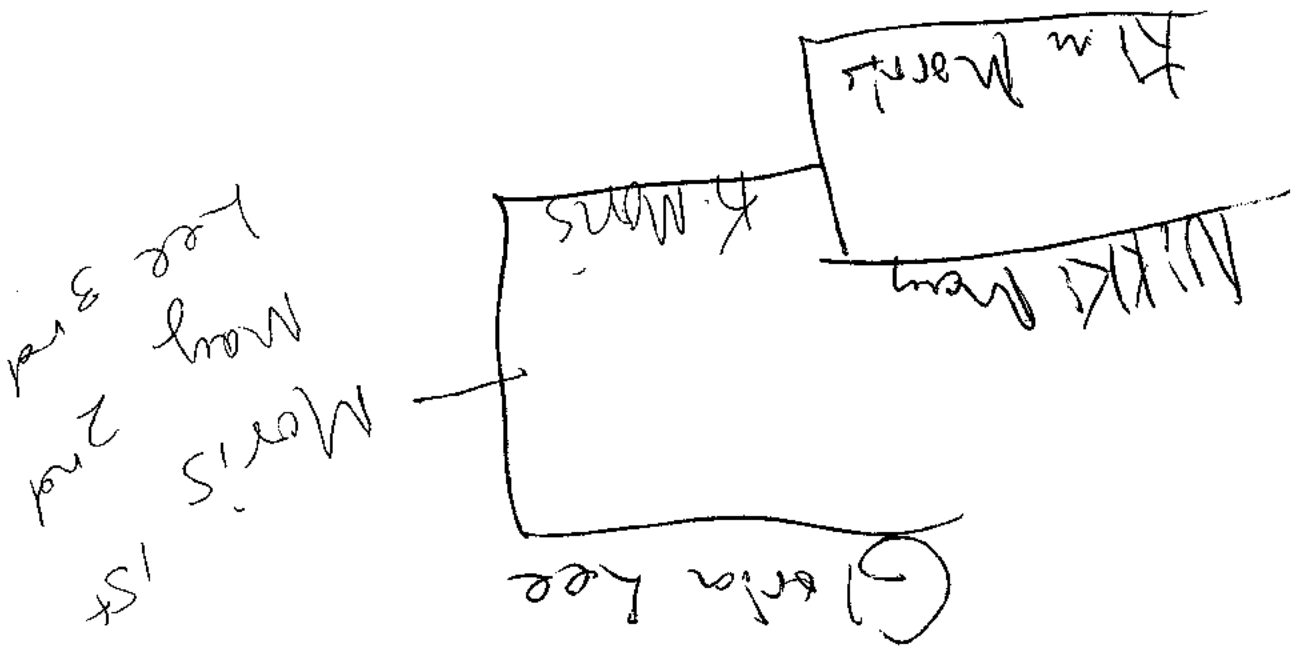

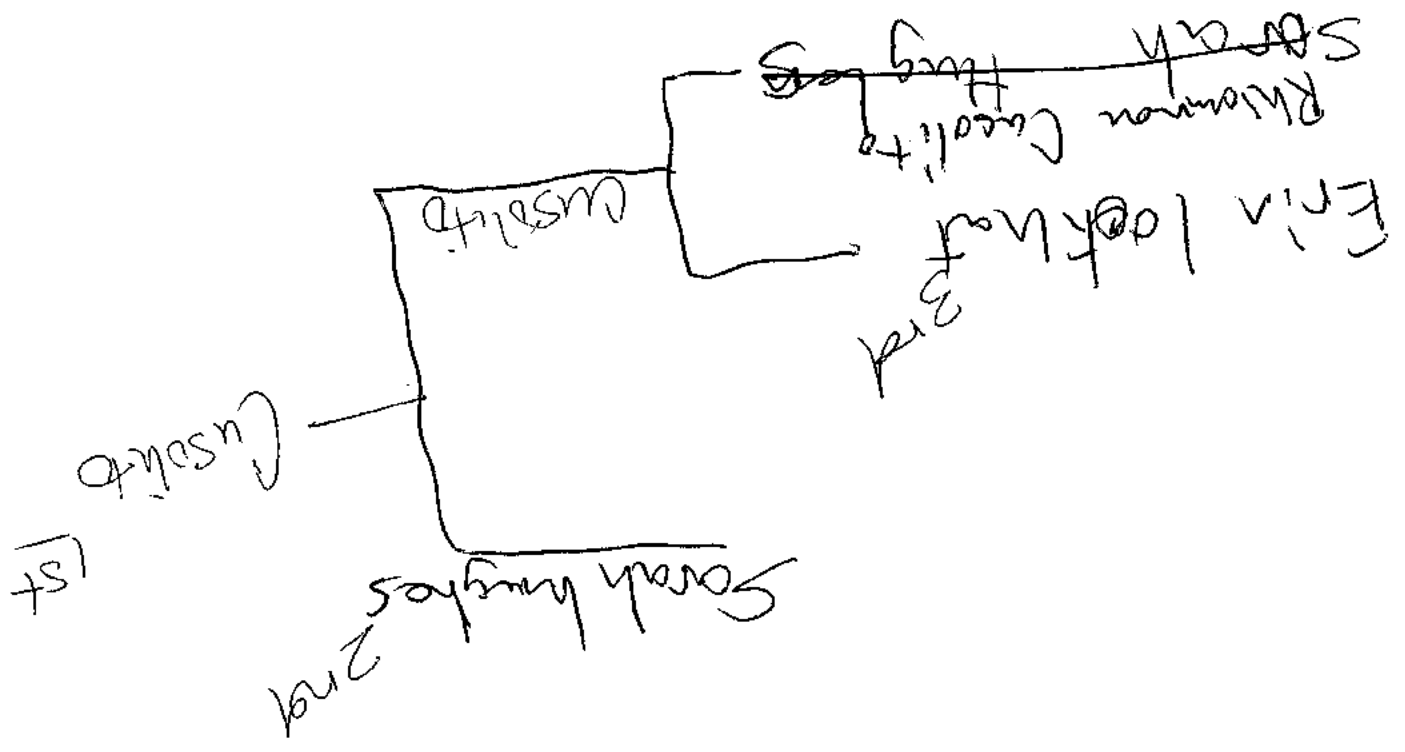

Female White Absolute Team

Name

Erin Lookhart

Sarah Hughes

Rishamon Cusolto

Craig

La Selva

SSBS

2

FEMALE - GI - BLUE/PURPLE BELT

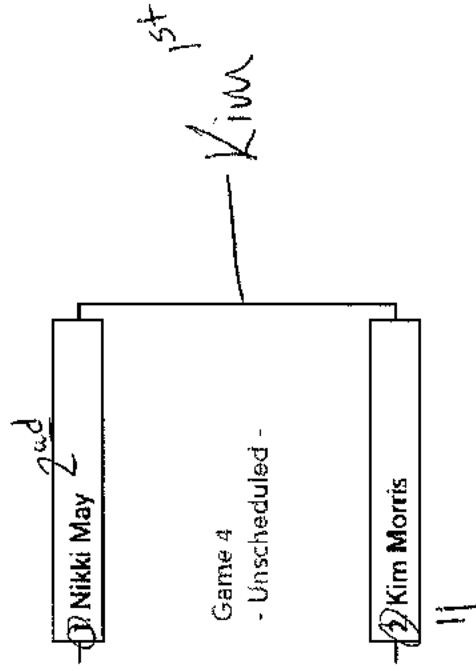

BRACKET

Dischewed

| | | |
|------------------|--------|-----------|
| DAN MORGAN | 4 vs 1 | Dischewed |
| CHARLES HERSCHKE | | A D |

Dischewed

| | | |
|----------------|--------|-----------|
| JAMIE KYLER | 2 vs 3 | Dischewed |
| JOSH LITTLETON | | A D |

Dischewed

| | | |
|------------------|--------|-----------|
| CHARLES HERSCHKE | 1 vs 3 | Dischewed |
| JOSH LITTLETON | | A D |

Dischewed

| | | |
|-------------|--------|-----------|
| DAN MORGAN | 4 vs 2 | Dischewed |
| JAMIE KYLER | | A D |

Dischewed

| | | |
|------------------|--------|-----------|
| JAMIE KYLER | 2 vs 1 | Dischewed |
| CHARLES HERSCHKE | | A D |

Dischewed

| | | |
|----------------|--------|-----------|
| JOSH LITTLETON | 3 vs 4 | Dischewed |
| DAN MORGAN | | A D |

W
 Charlie 11
 Jamie 1
 Josh 11
 Dan 11

8

MALE - GI - WHITE BELT - MASTERS 30+ - 168-181 LBS

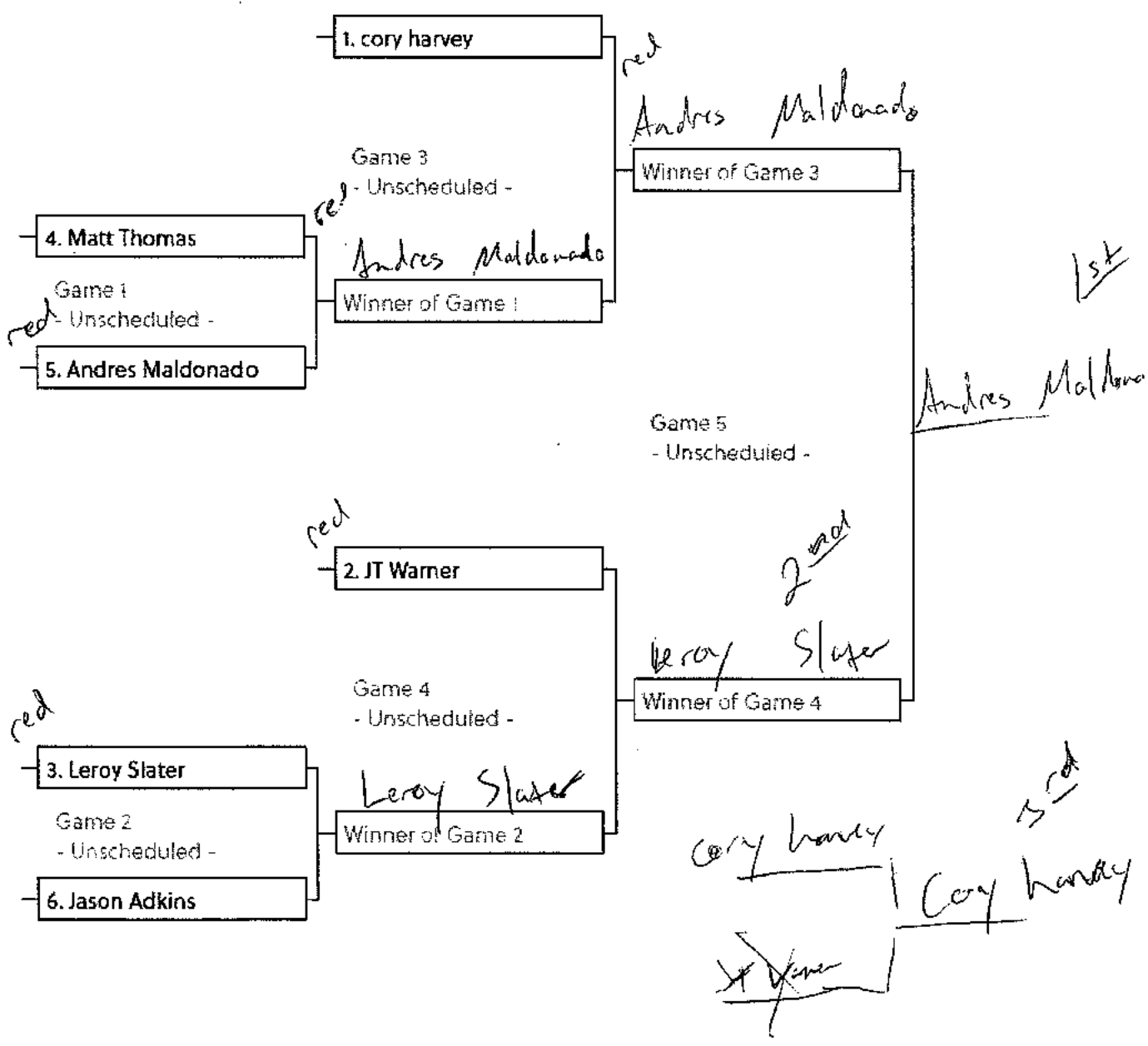

MALE - GI - WHITE BELT - 19-29 Y/O - 155-167 LBS

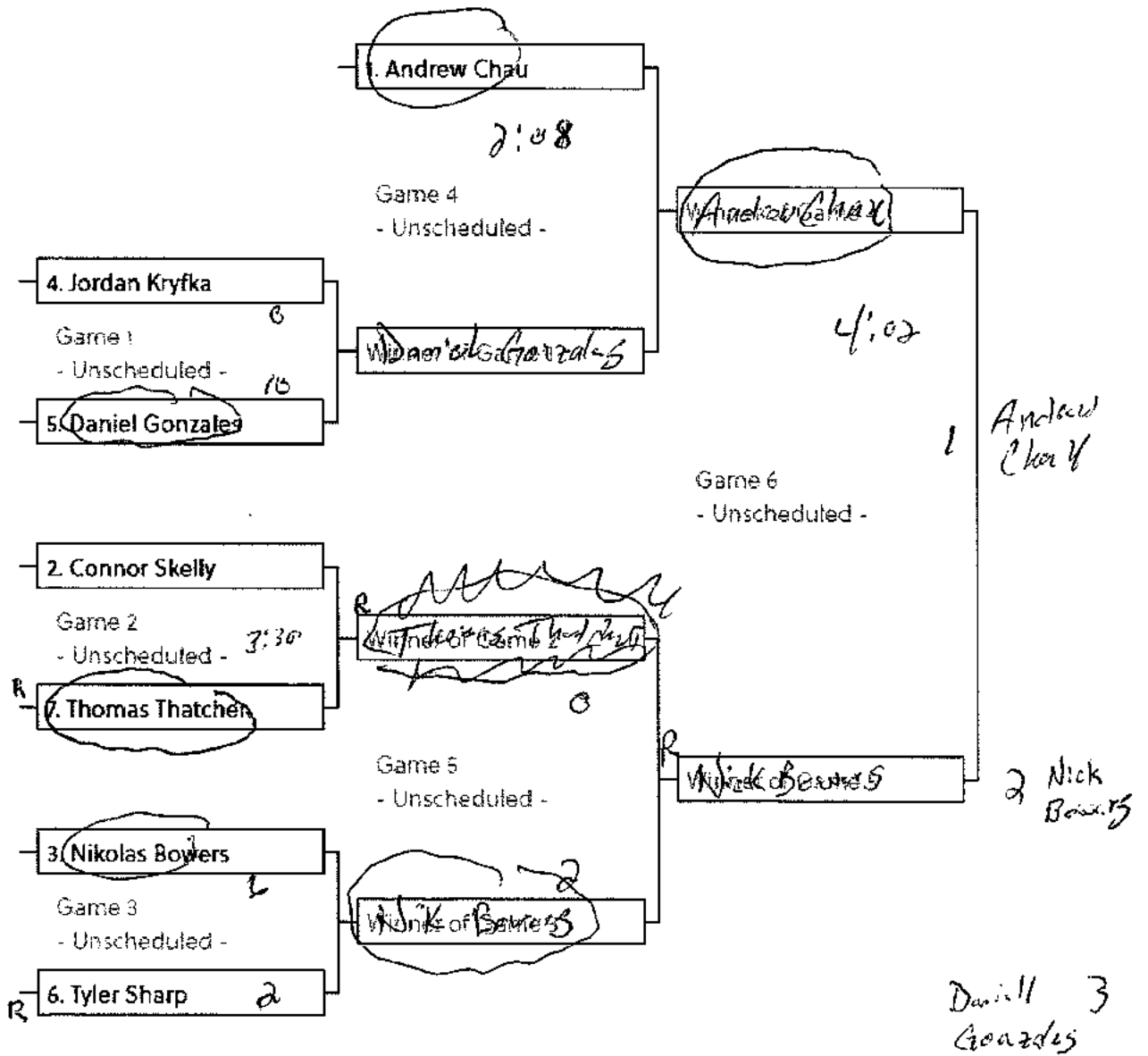

5

5 min

MALE - GI - WHITE BELT - MASTERS 30+ - 182-194 LBS

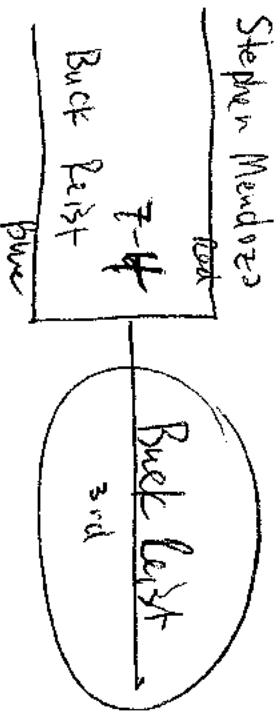
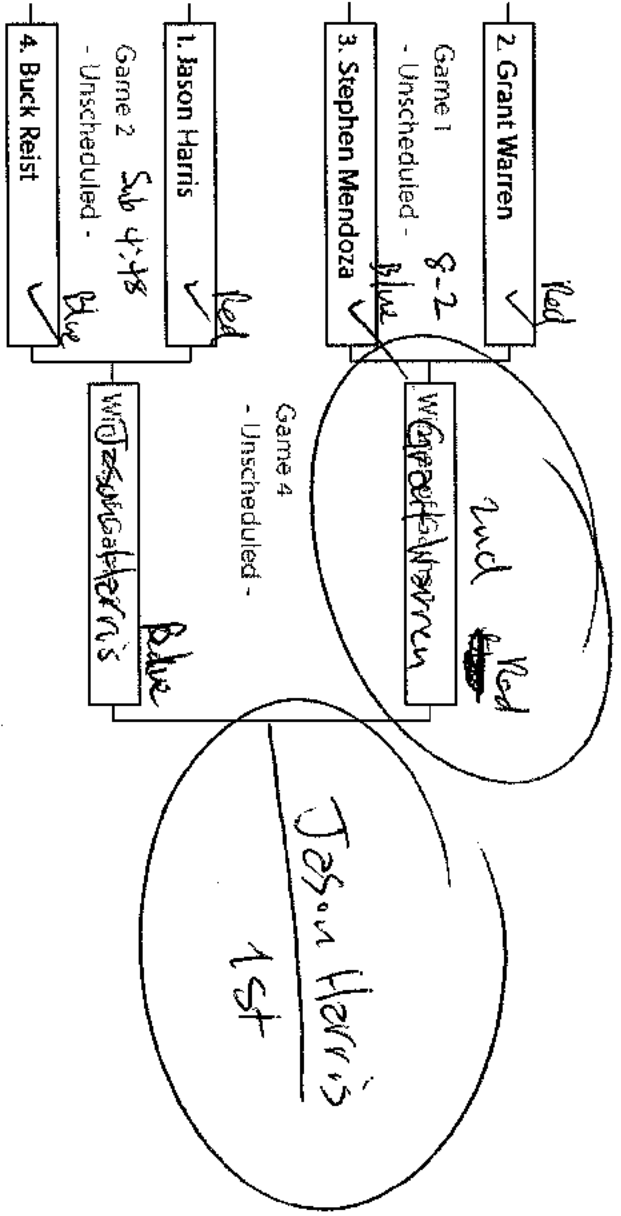

MALE - GI - WHITE BELT - MASTERS 30+ - 195-207 LBS

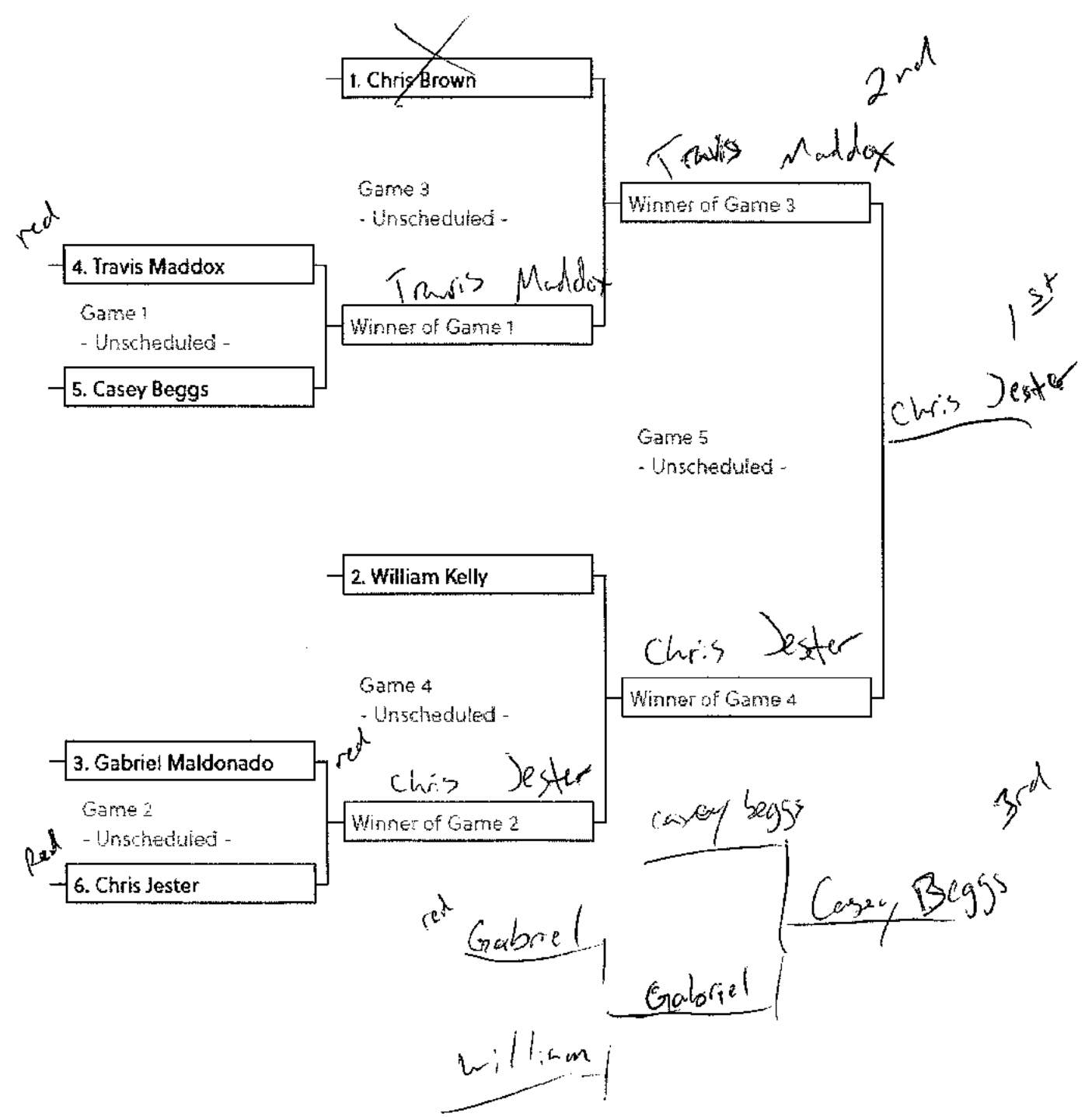

Sum's

MALE - GI - BLUE BELT ABOVE 221

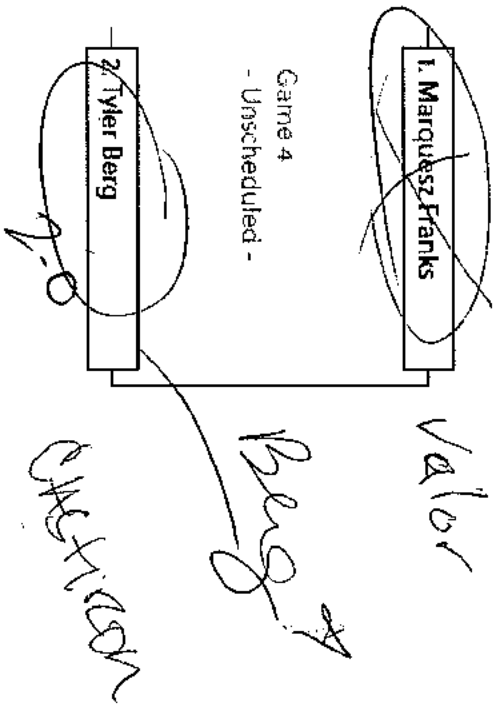

5

MALE - GI - BLUE BELT - MASTERS 30+ - 168-181

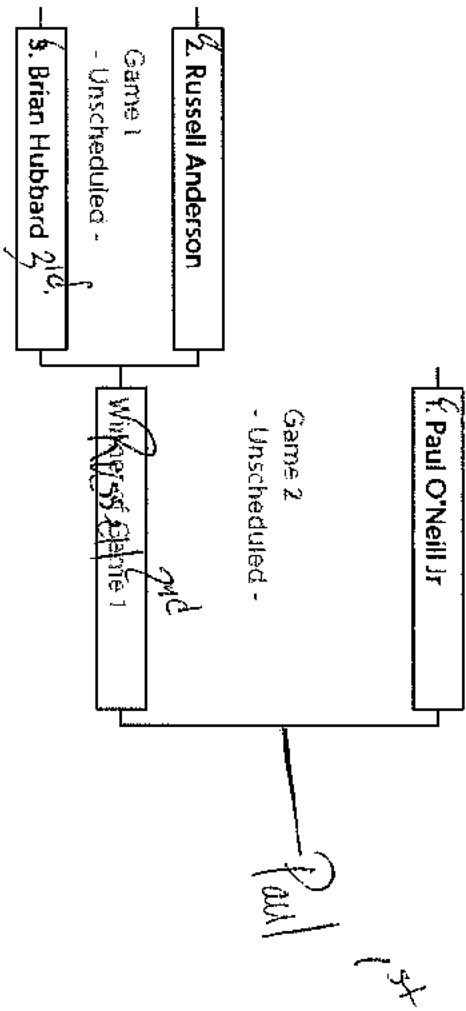

6

8

MALE - GI - WHITE BELT - 19-29 Y/O - 142-154 LBS

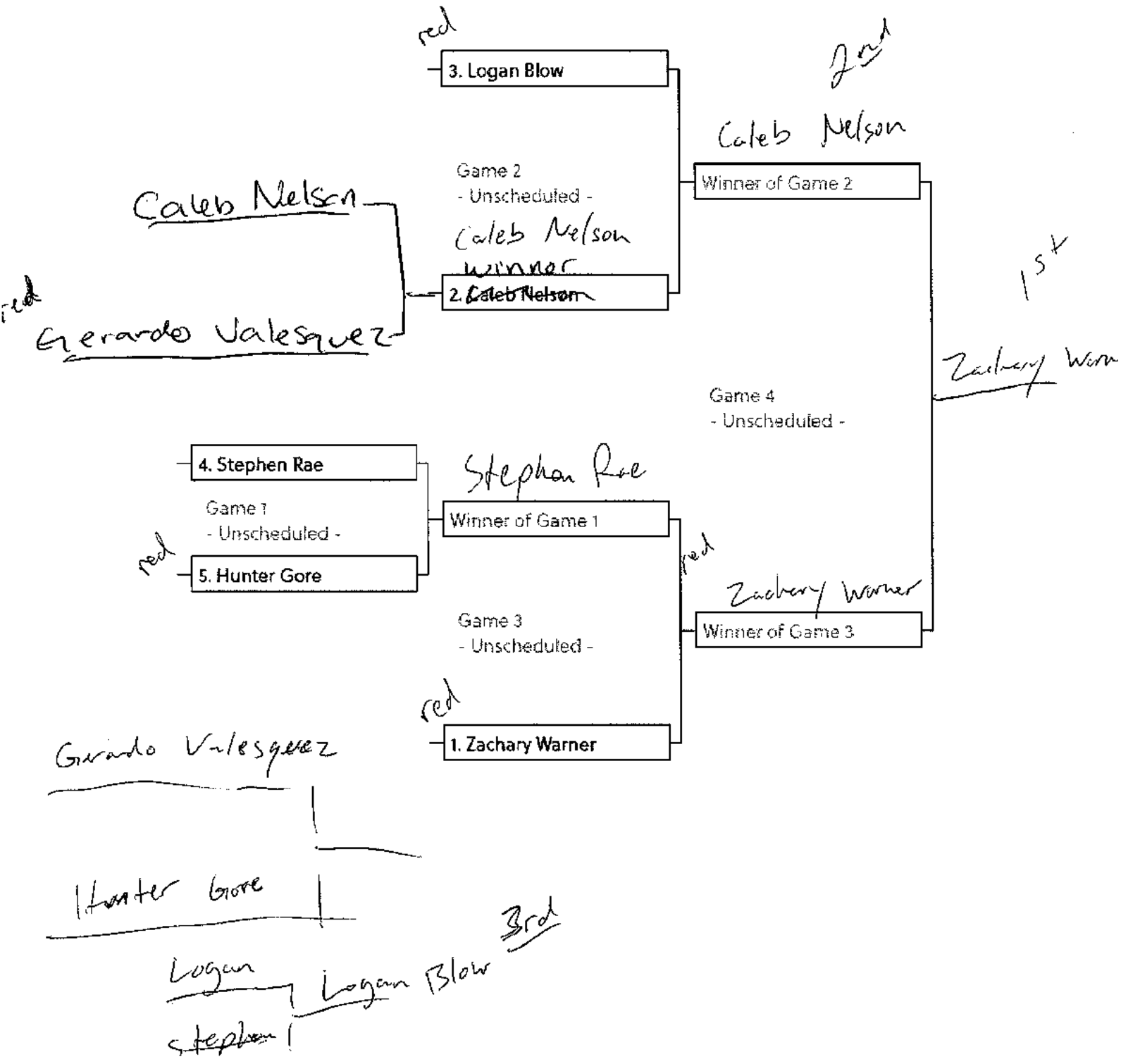

6

MALE - GI - WHITE BELT - VETERANS 40+ - 155-167 LBS

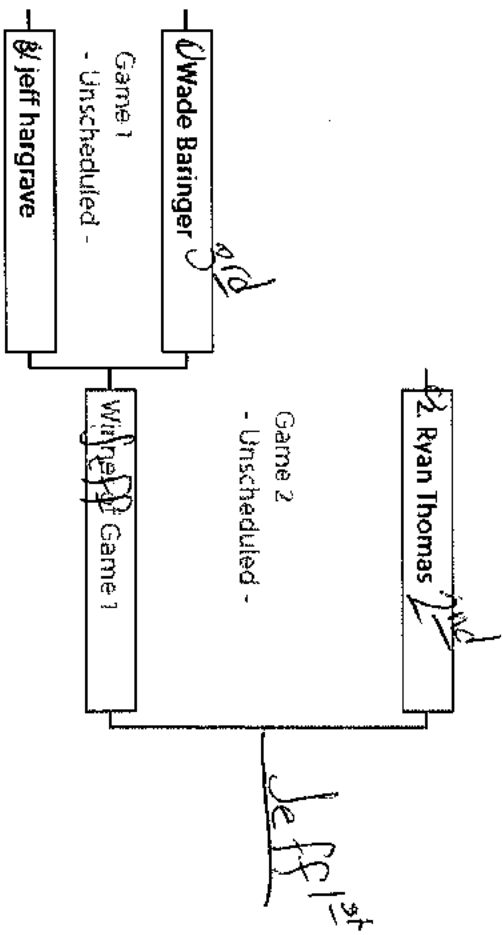

5 min

5

MALE - GI - WHITE BELT - MASTERS 30+ - 155-167 LBS

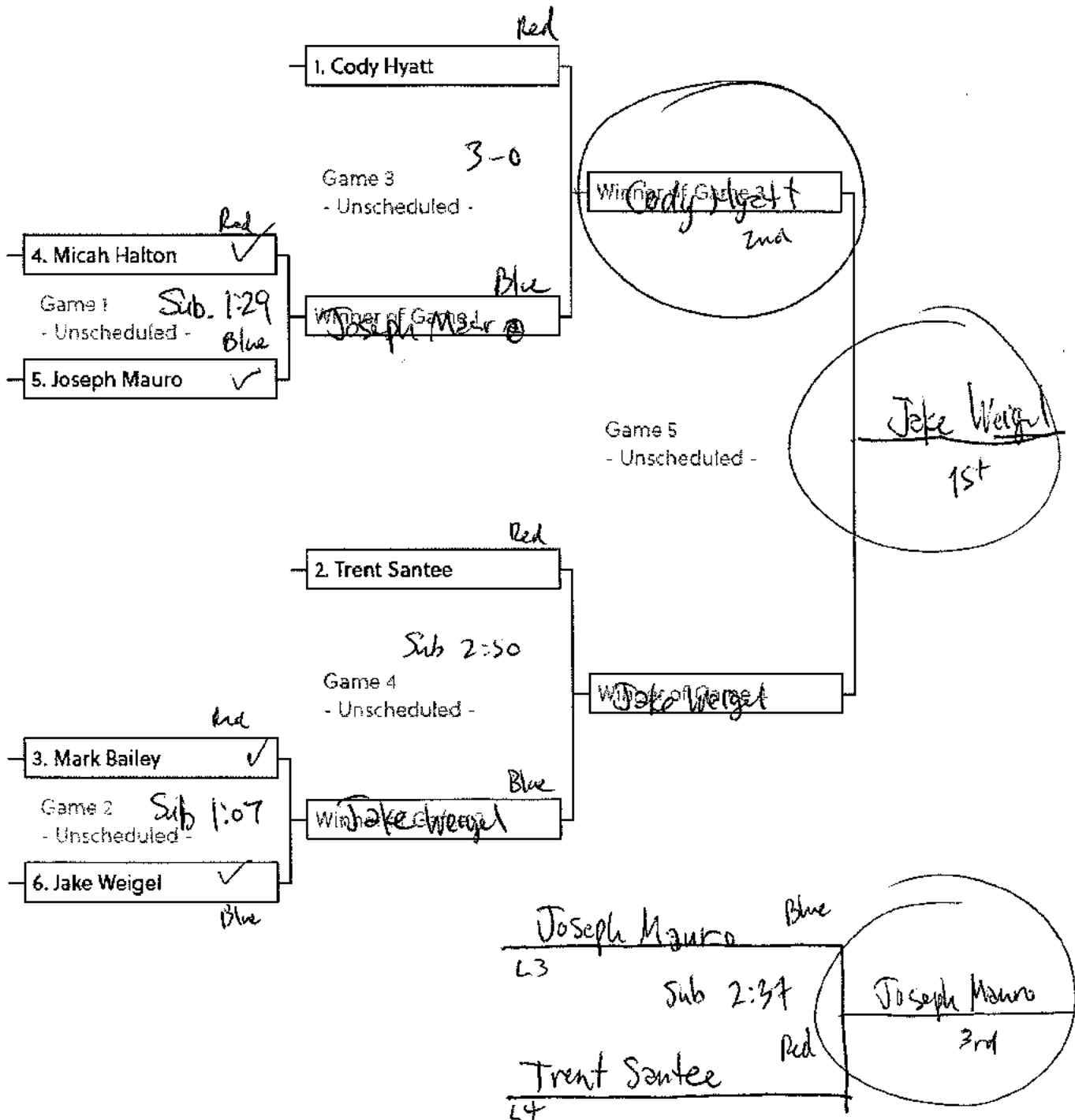

5

5 min

MALE - GI - WHITE BELT - VETERANS 40+ - 185-205LBS

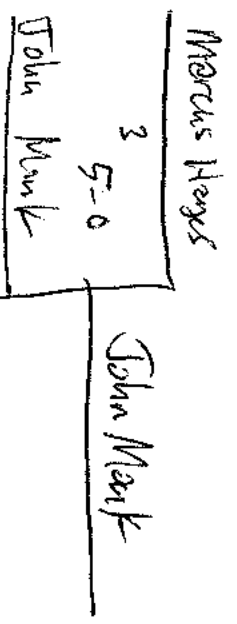
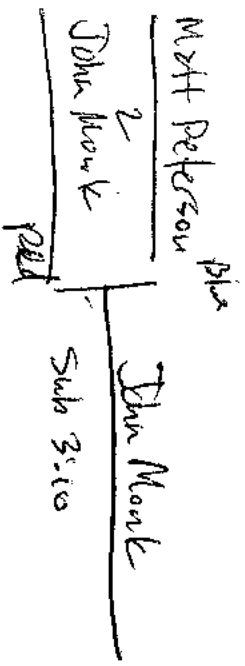
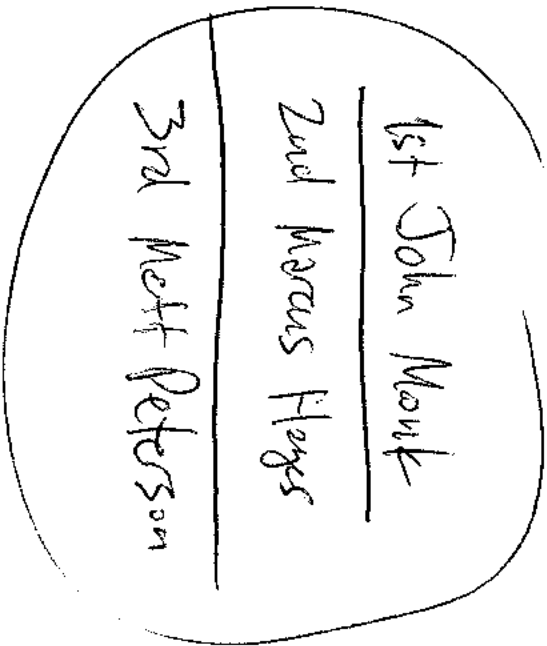
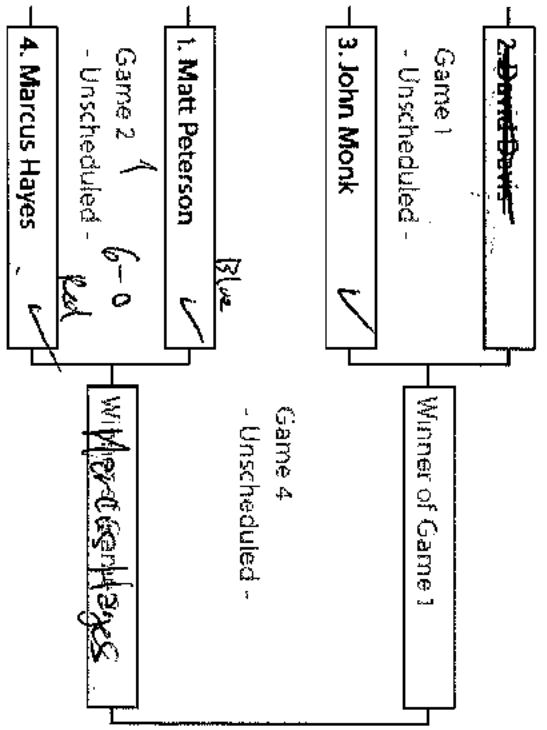

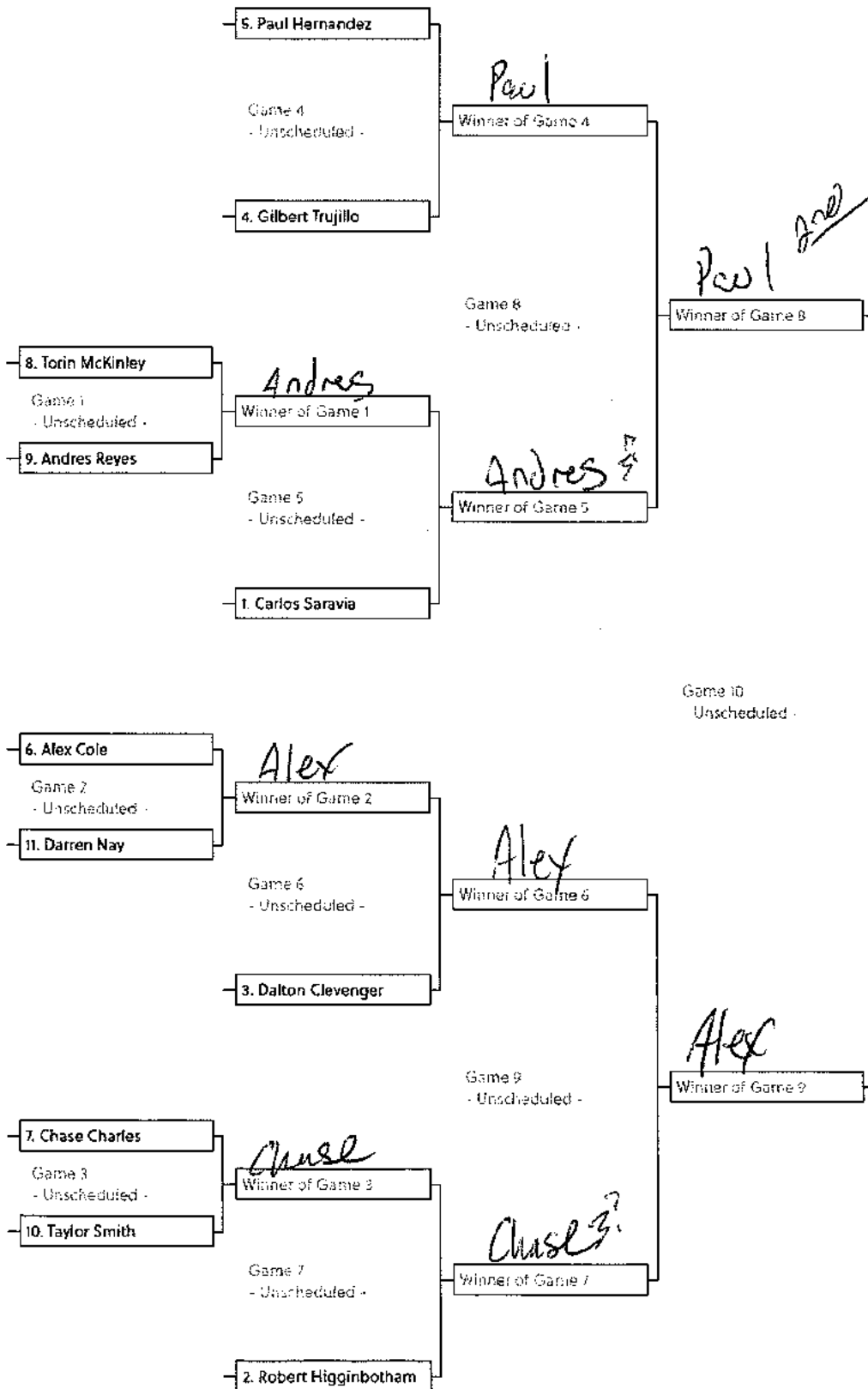

1st
Alex
2nd
Paul
3rd
Chase

MALE - GI - BLUE BELT - MASTERS 30+ - 155-167

✓

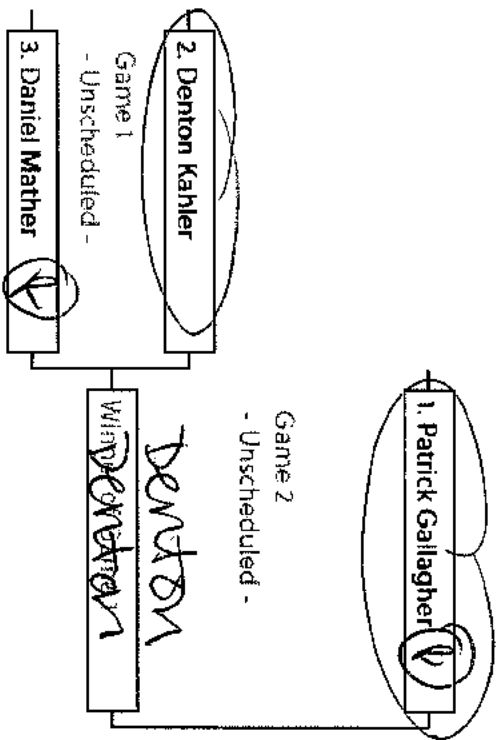

Patrick

Daniel

1st

Patrick

2nd

Denton

3rd

Daniel ✓

MALE - GI - WHITE BELT - VETERANS 30+ - ABOVE 221LBS

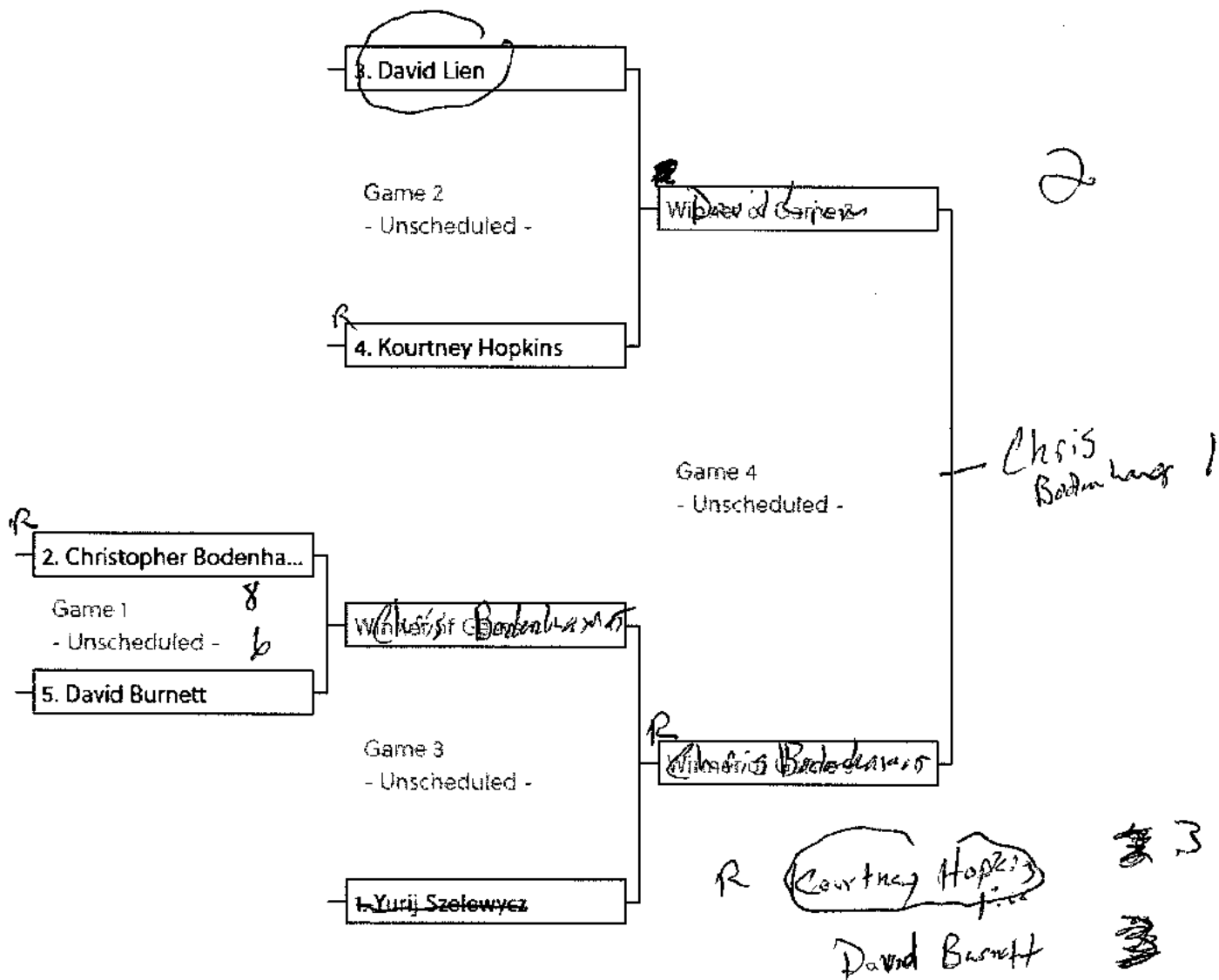



MALE - GI - BLUE BELT - MASTERS 30+ - 220-235

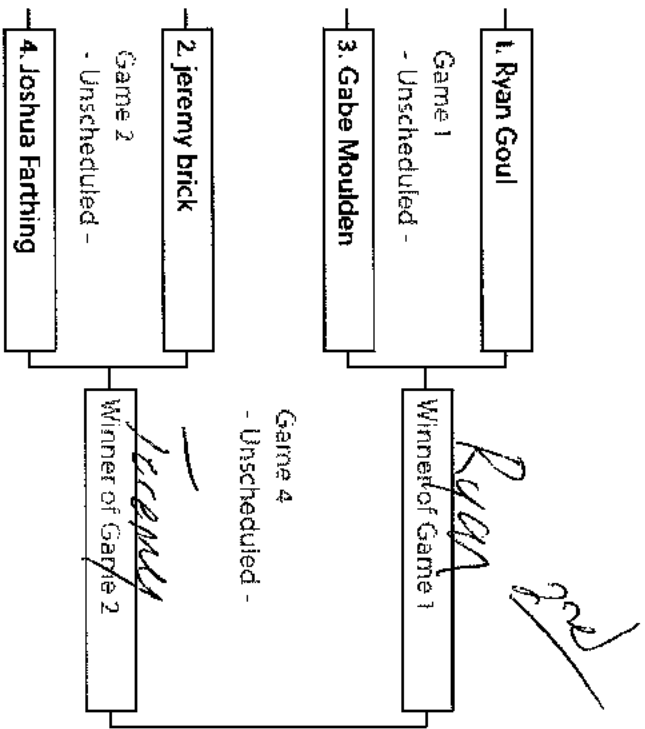

Ryan
3rd

Jeremy

1st
3rd

3rd
2nd
1st
Joshua

4

Omnia

MALE - GI - WHITE BELT - 19-29 Y/O - ABOVE 221 LBS

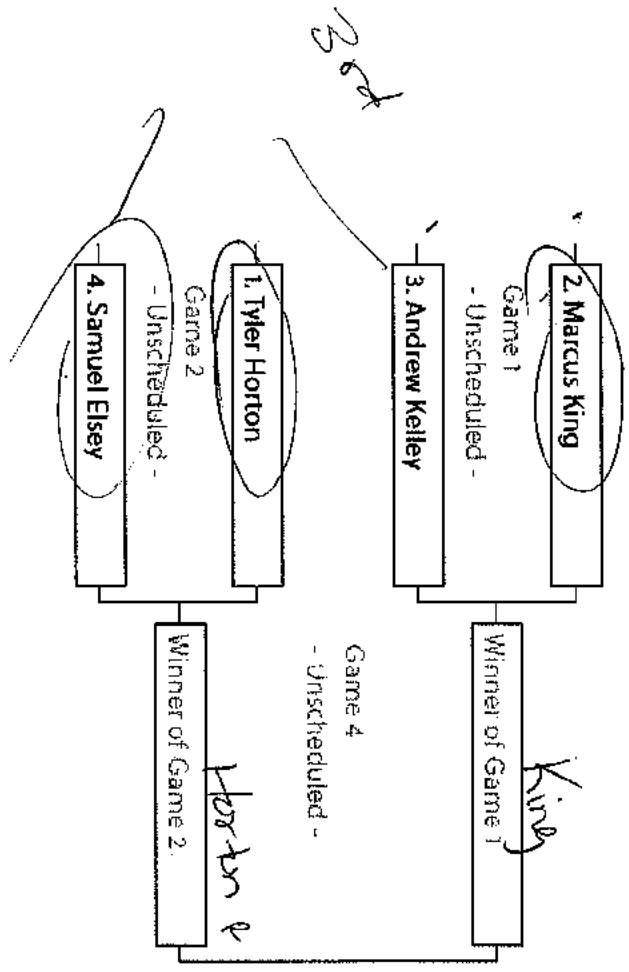

1st
 Horton 2nd
 King 3rd
 Eisey 4th

MALE - GI - WHITE BELT - MASTERS 30+ - 142-154 LBS

5

Benedict

Nathan

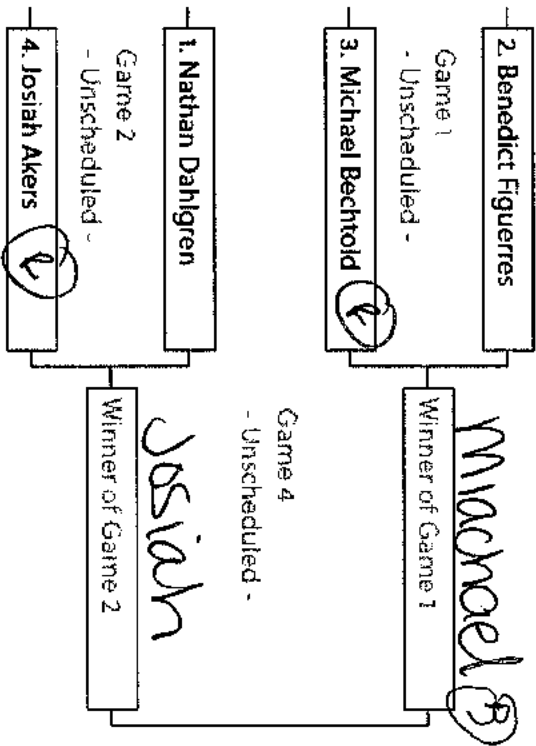

1st Michael

2nd Josiah

3rd Benedict

7

MALE - GI - BLUE BELT 140-154

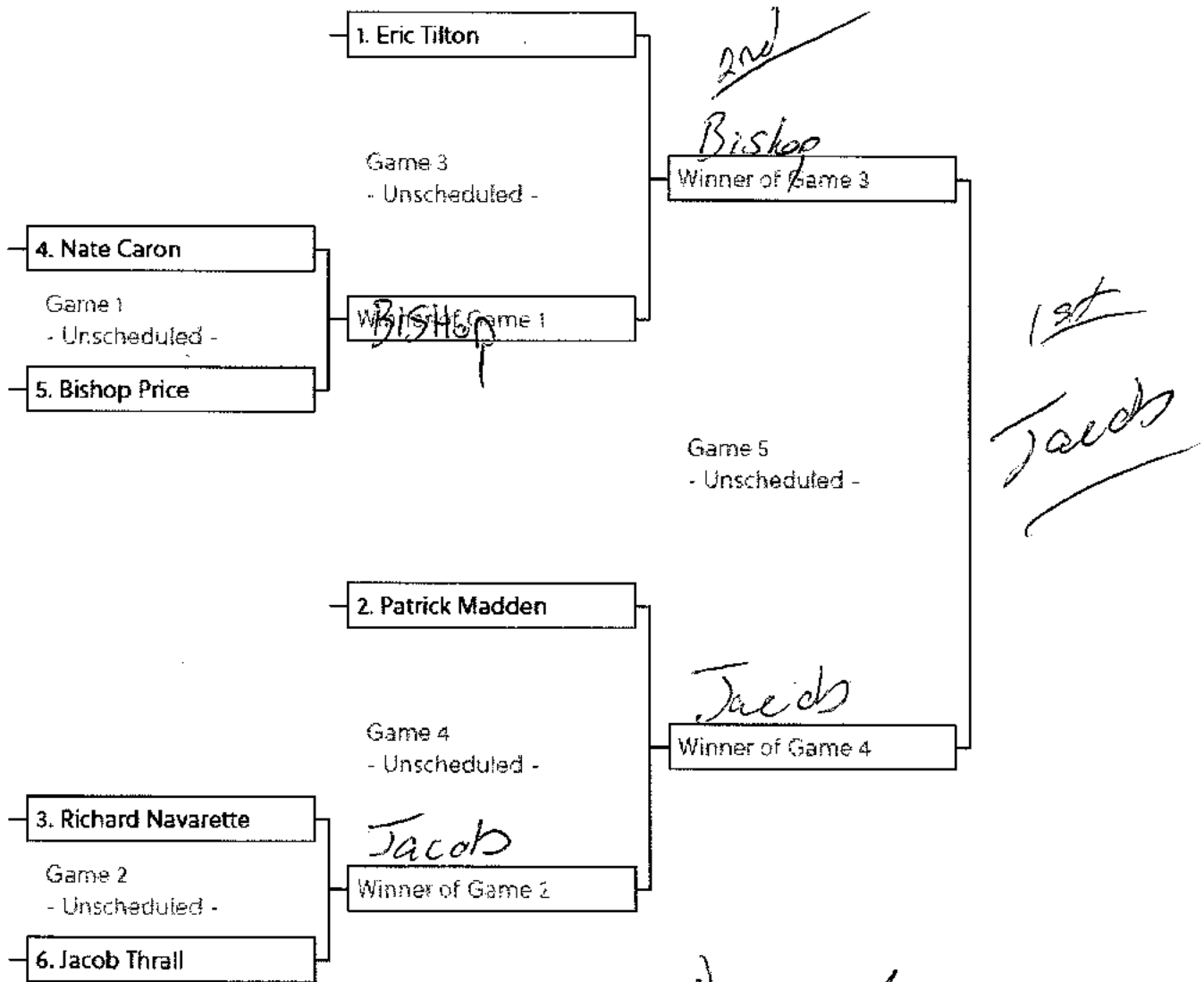

Eric = 3rd
Patrick = Patrick

MALE - GI - PURPLE/BROWN/BLACK - 30+ - 182-207

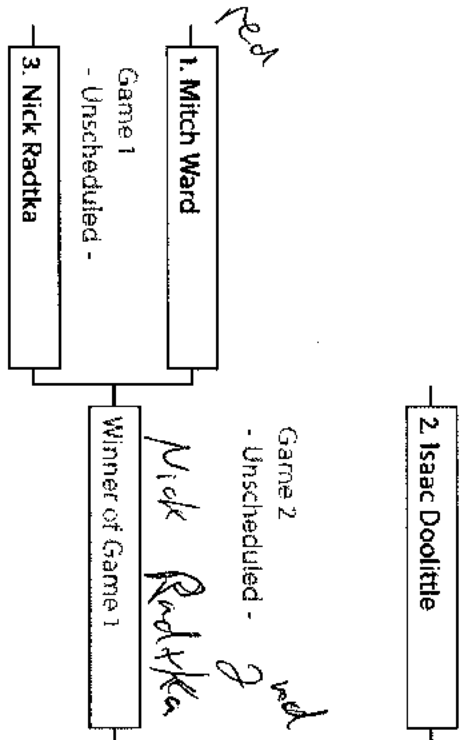

red

red

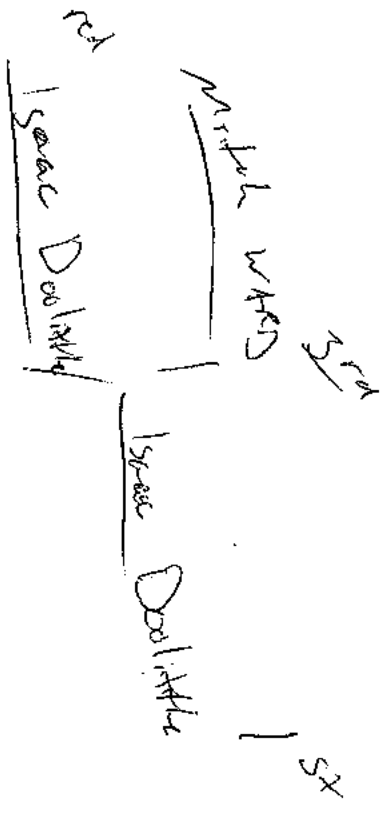

8

MALE - GI - BLUE BELT 155-167

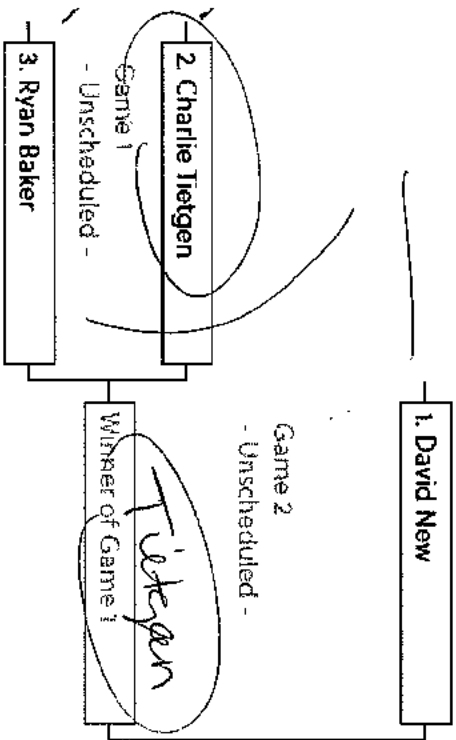

1st
Tietgen 2nd
Baker 3rd
New

f

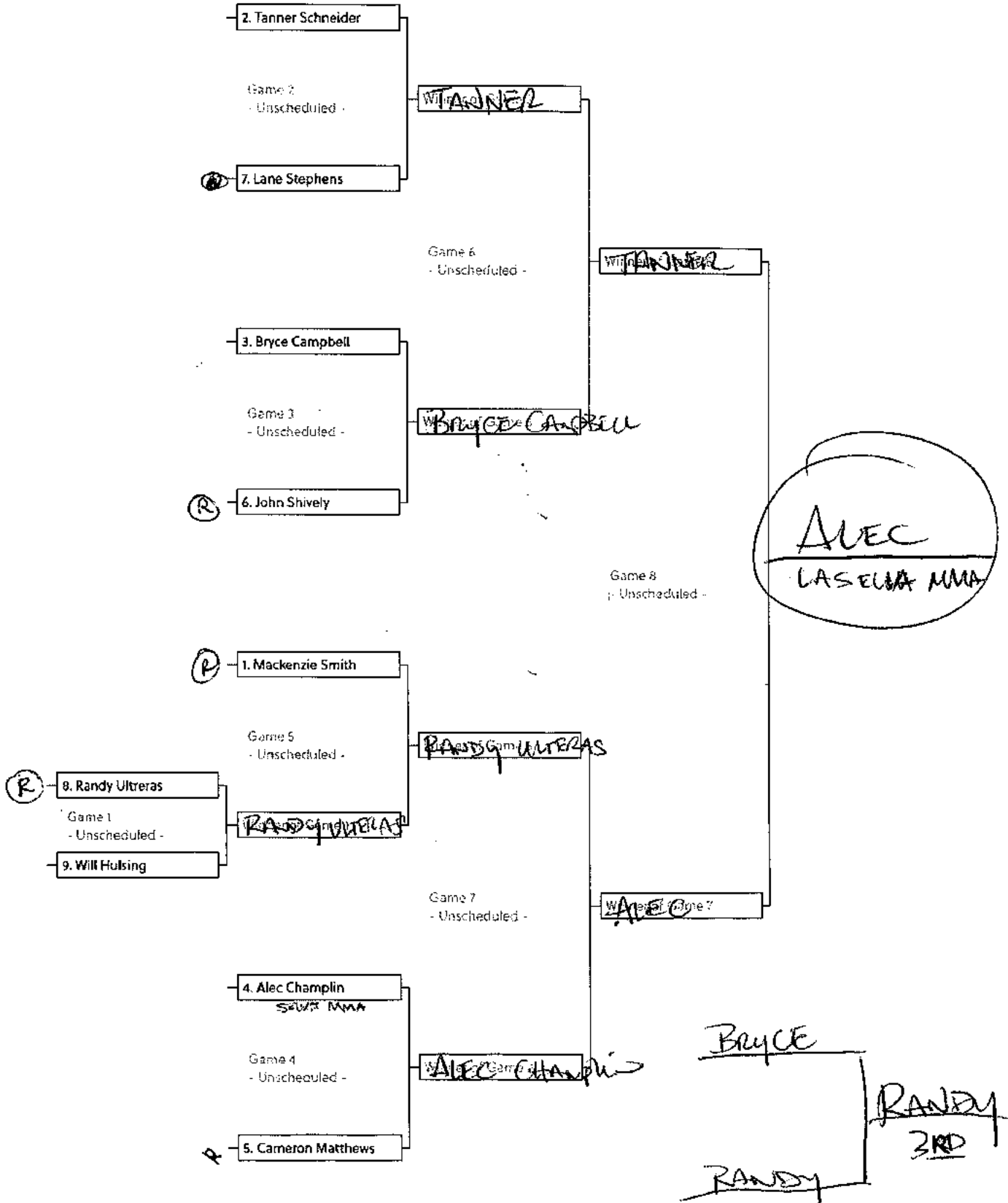

Lwin

Round Robin

MALE - GI - BLUE BELT 208-221

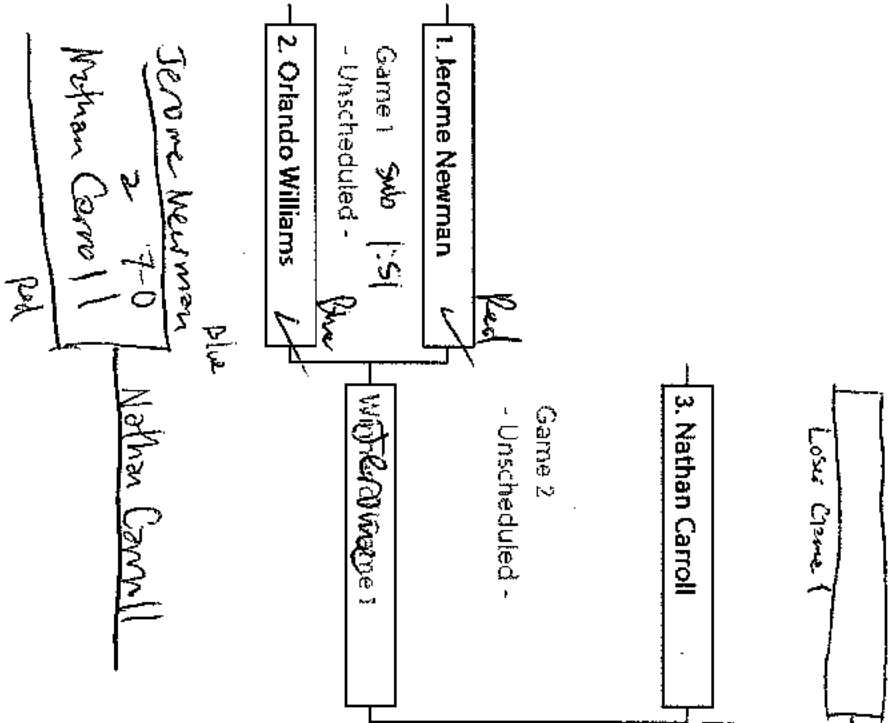

1st Nathan Carroll

2nd Jerome Newman

3rd Orlando Williams

Orlando Williams (Blue) vs Nathan Carroll (Red) 3-29, 3:46

Nathan Carroll

Nathan Carroll

5

5

5mins

MALE - GI - WHITE BELT - 19-29 Y/O - 195-207 LBS

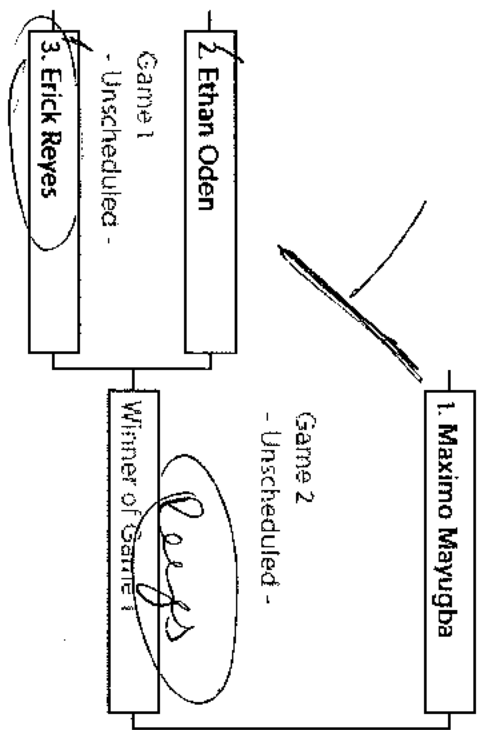

1st
 Reyes
 Mayugba 2nd
 Oden 3rd

MALE - GI - BLUE BELT - MASTERS 30+ - 128-154

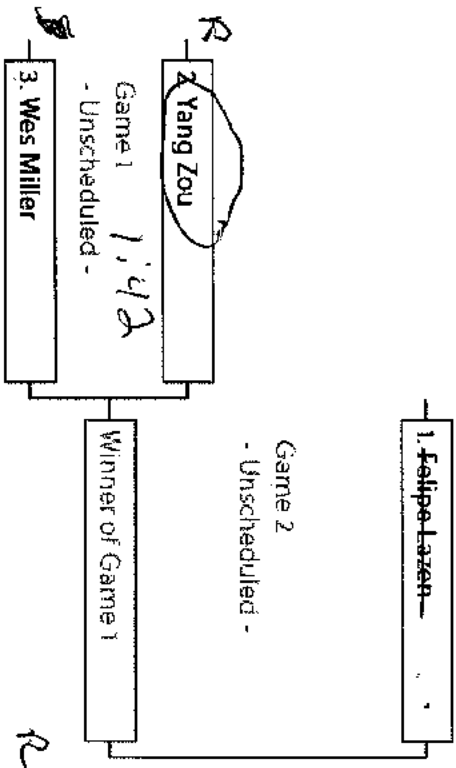

Zou
1
Wes Miller
2

2

UM
|

MALE - GI - BLUE BELT - MASTERS 30+ - 182-207

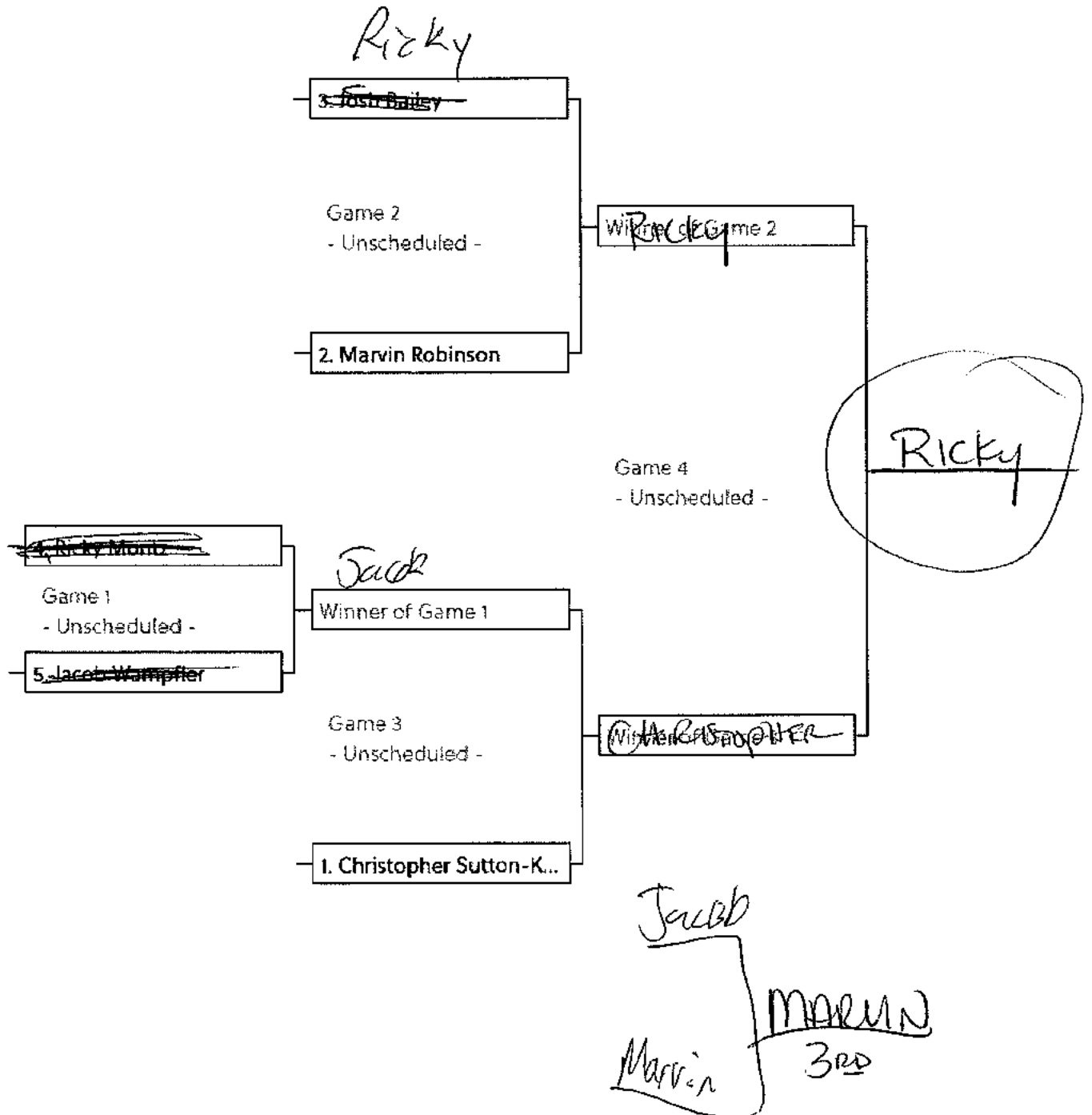

6

MALE - GI - WHITE BELT - MASTERS 30+ - ABOVE 221

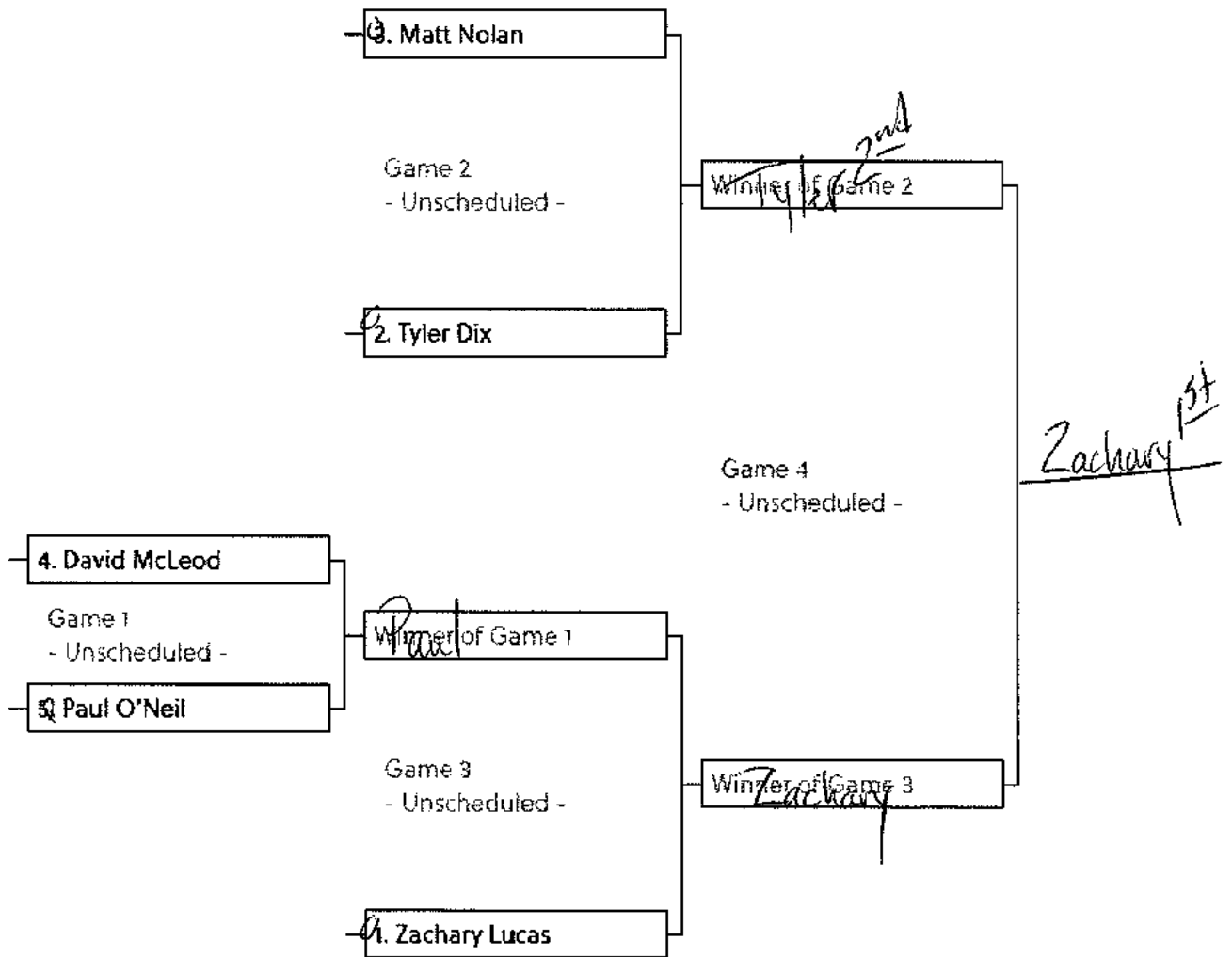

Matt
Paul | Paul
Paul | 3rd

Wake up amp...

BM HDSobute

Morvin Robinson
Red
Sub 4:56

Nathan Robinson

Norvin Robinson
Blue

Sub 3:17
Q1

Marquesz Franks 2a

Charlie Tietgen

Marquesz Franks
Blue

Marquesz Franks

Jerome Newman

Jerome Newman
Red

1st
Nathan Carroll
~~Marquesz Franks~~

Jacob Thrall

Wes Miller

Nathan Carroll

Nathan Carroll
Red

Sub 1:06

Nathan Carroll
Red

Kang Zou
Blue

Nathan Carroll

Will Madden

Blue
Sub 1:42
Jeremy Brick
Red

Jeremy Brick
Red

Q2

Top 3:25

Jeremy Brick
Blue

Ryan Boul
Blue

Morvin Robinson
Blue
Loser Q1

3rd
Morvin Robinson

Jeremy Brick
Loser Q2
Red

Male

Purple/Brown

Absolute #13

Name

Team

Shawn Aldrich

Valor MMA

Sean French

ATTACK

Brad Seppen

CSC

Travis Turner

CSC

Sean French ^{3rd}

Brad Seppen

Brad

Brad

Travis Turner (2)

Travis

Shawn Aldrich

~~Sean~~
~~Brad~~

~~Justin~~

Travis

← ~~Shawn~~

~~Travis~~
~~Justin~~

Male White AD Colwe

^{red} Tyler Horton

Chris Bodenhauer

Tyler Horton

^{red}

Tyler Horton

Stephen Ra

Chase Charles

Semi Final

^{red}

Chase Charles

^{red} Andrew Chaw

^{red}

Andrew Chaw

^{red}

Tyler Dix

^{red}

3rd

Tyler Dix

~~Stephen Merdoza~~

Josiah Akers

Josiah Akers

Semi Final

Mat Nelson

^{red}

Tyler Sharp

Tyler Sharp

1st
Tyler Horton

2nd
Tyler Sharp

1

GM

MALE - G1 - PURPLE/BROWN/BLACK - 30+ - ABOVE 221

Round 1:

Round 2:

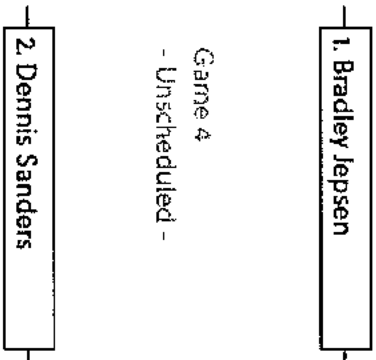

BRADLEY

MALE - GI - PURPLE/BROWN/BLACK - 167-181

Calvin (P)

Sean
~~Sean~~

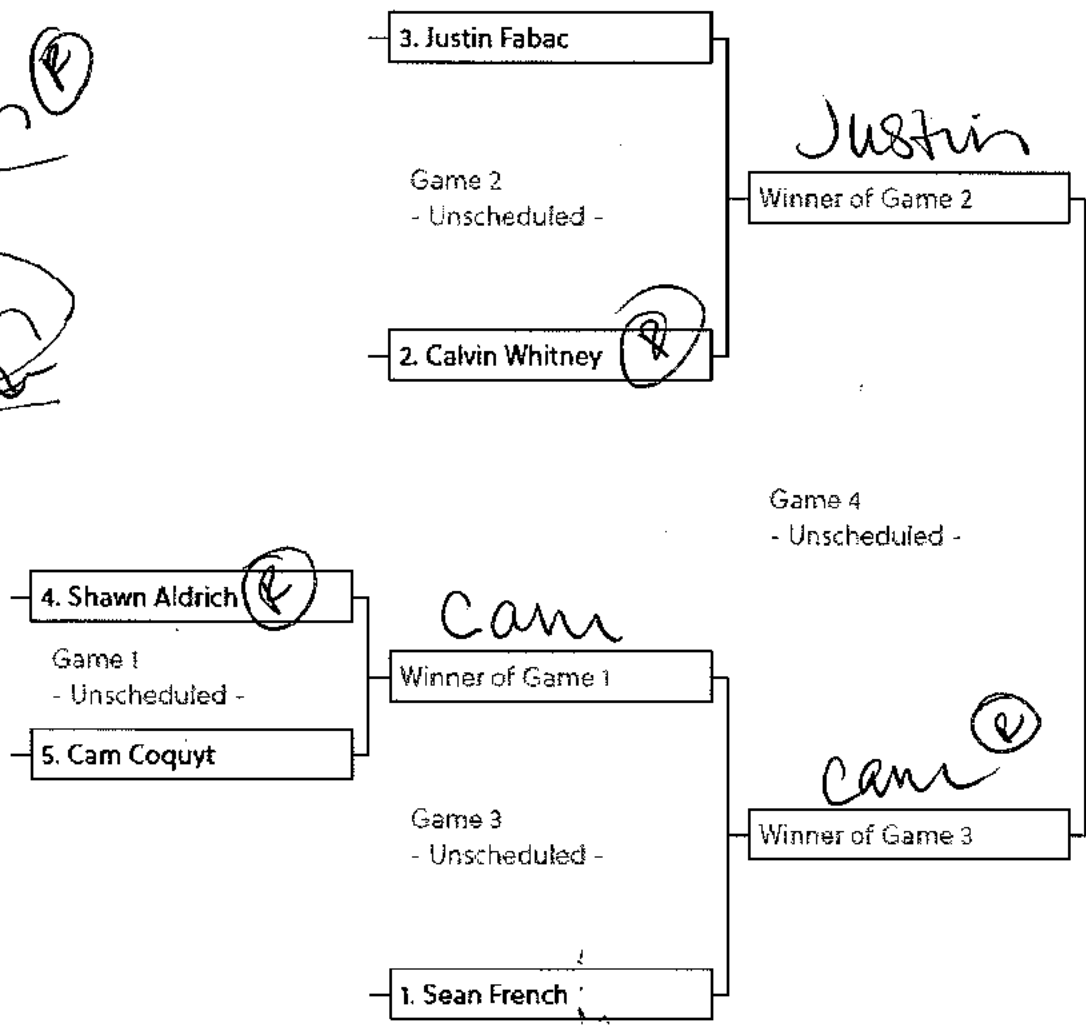

1st Justin

2nd Cam

3rd Sean

Justin

MALE - GI - BLUE BELT 195-207

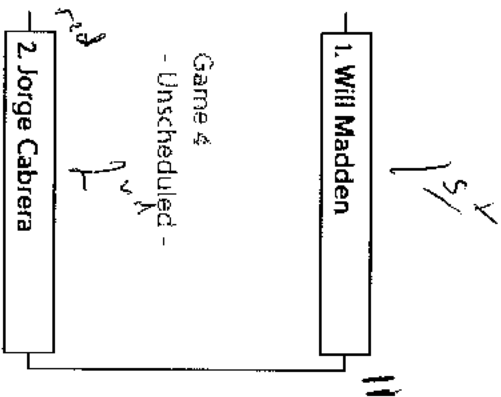

5

benin

MALE - GI - BLUE BELT - MASTERS 40+ - 195-207

Round Robin

1. Red Dee
~~Red Dee~~

Game 2
- Unscheduled -

2. Gary Evans
~~Red~~

Game 1 Subo 2/24
- Unscheduled -
~~Blue~~

3. Adam Noll
~~Blue~~

~~Winners~~
Adam Noll

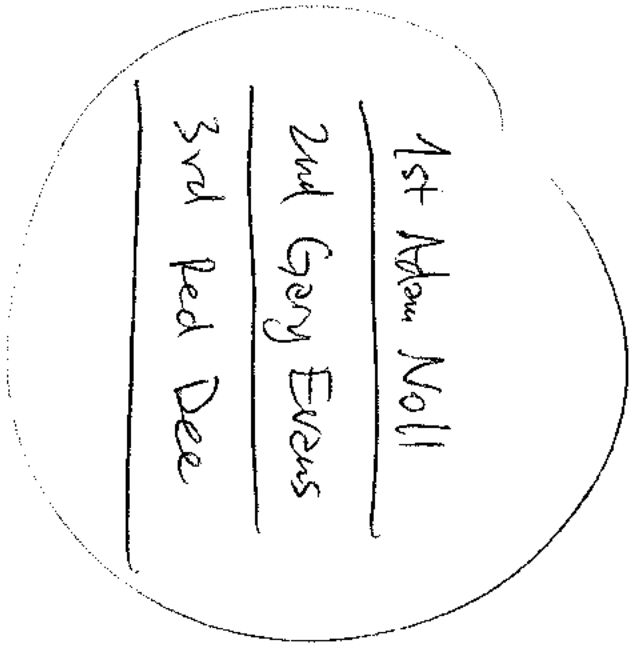

Red Dee ✓
~~Blue~~

~~OT Takedown~~

Gary Evans
~~Red~~

Gary Evans

Red Dee
Sub 3
3:46
~~Red~~

Adam Noll
~~Blue~~

Adam Noll

to win

MALE - GI - PURPLE/BROWN/BLACK - 30+ - 155-181

Round Robin

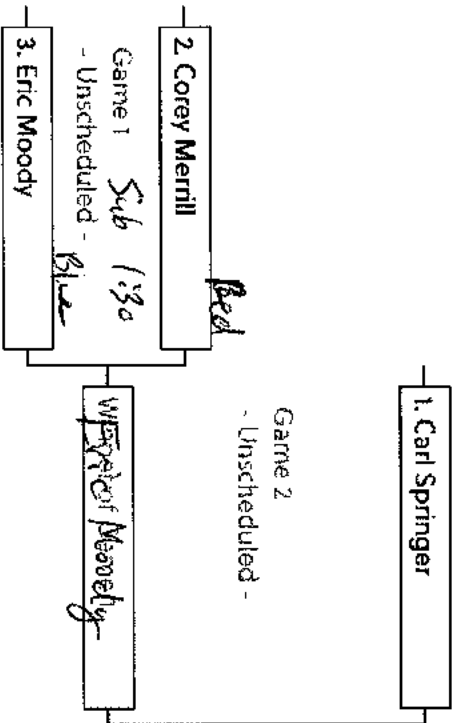

- 1st Carl Springer
- 2nd Eric Moody
- 3rd Corey Merrill

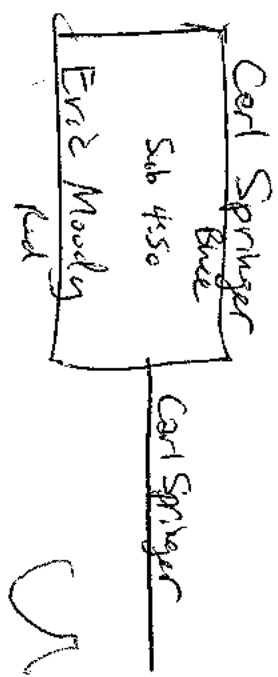
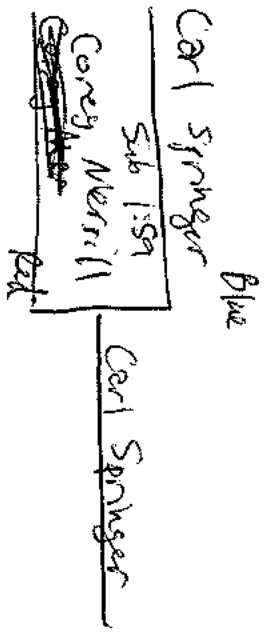

3

5

MALE - GI - WHITE BELT - MASTERS 30+ - 208-221 LBS

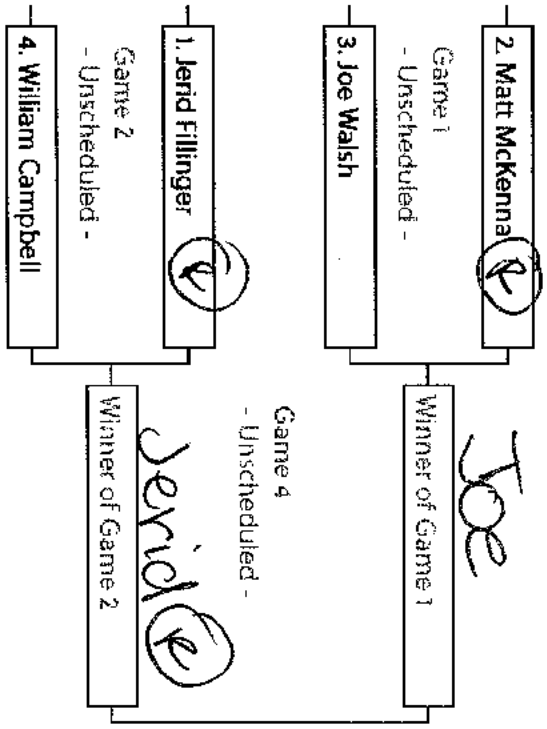

Matt Ⓟ

William

1st Joe

2nd Jerid

3rd Matt

6

MALE - GI - BLUE BELT 167-181

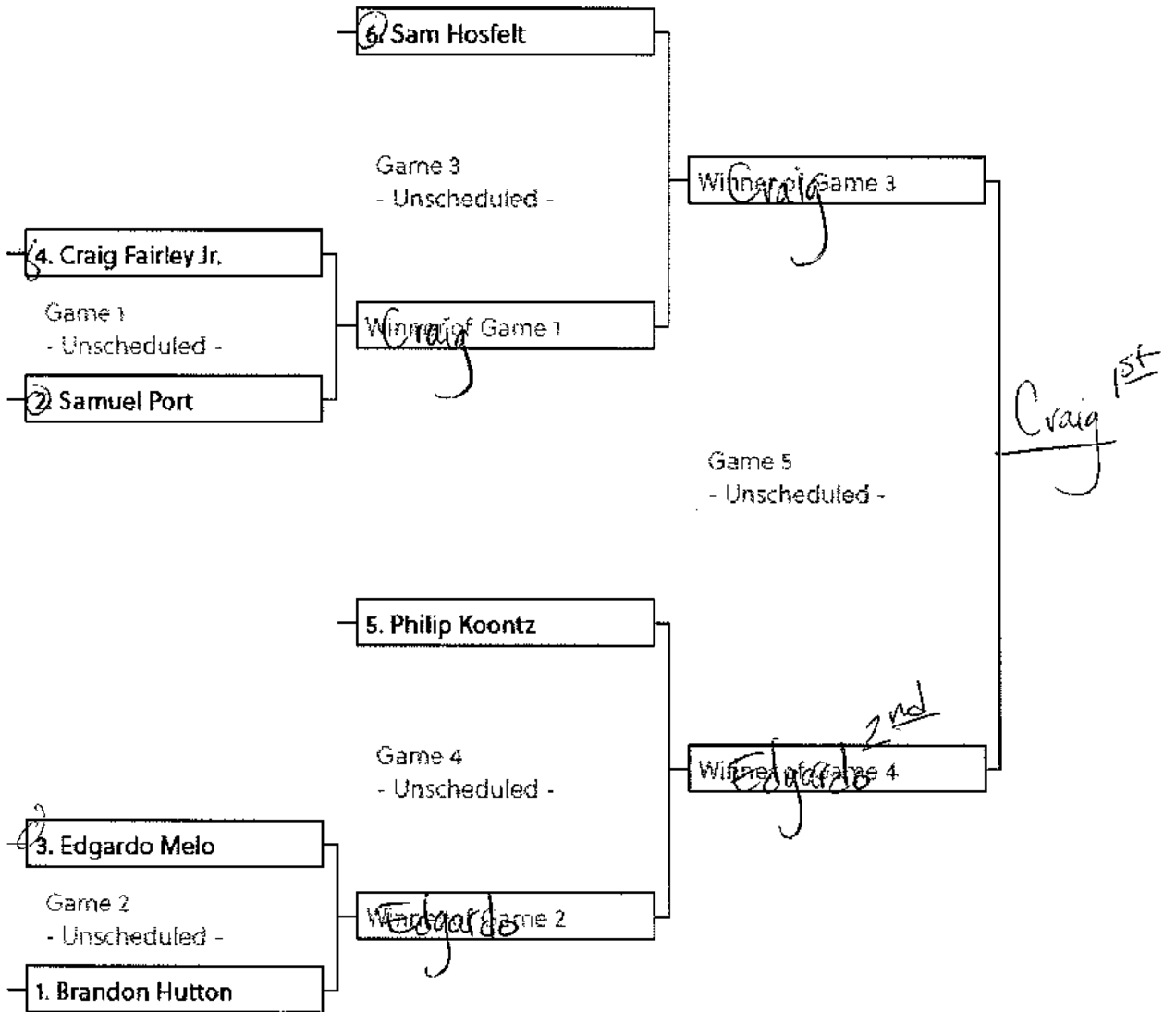

Sam
 Phillip | Sam
 3rd

MALE - GI - BLUE BELT - MASTERS 40+ - 208-221

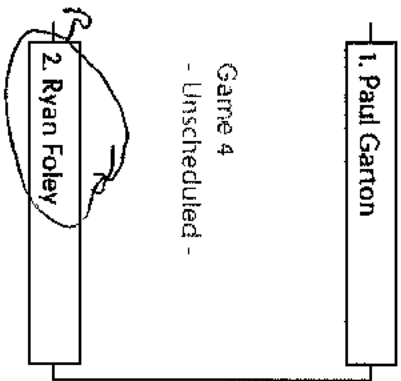

R Ryan Foley

Paul Ganton
3:31

R Ryan Foley 1
Paul Ganton 2

MALE - GI - PURPLE/BROWN/BLACK - 30+ - 208-221

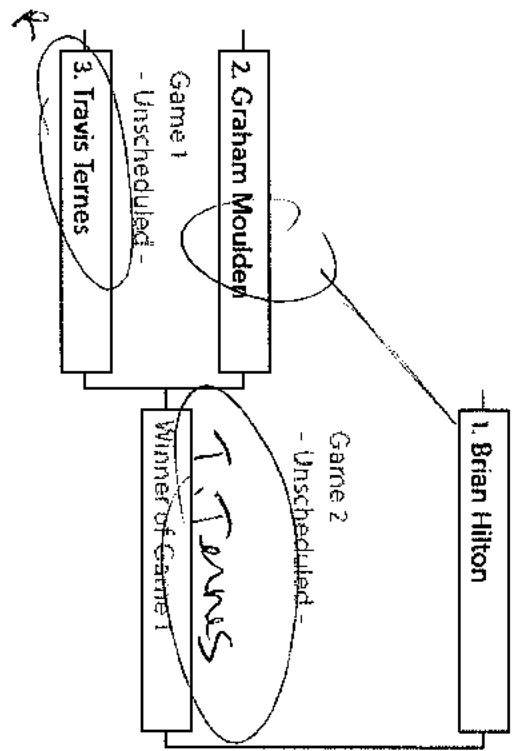

Ternes 1st
Moulder 2nd
Hilton 3rd

M

v

MALE - GI - BLUE BELT - MASTERS 40+ - 170-190

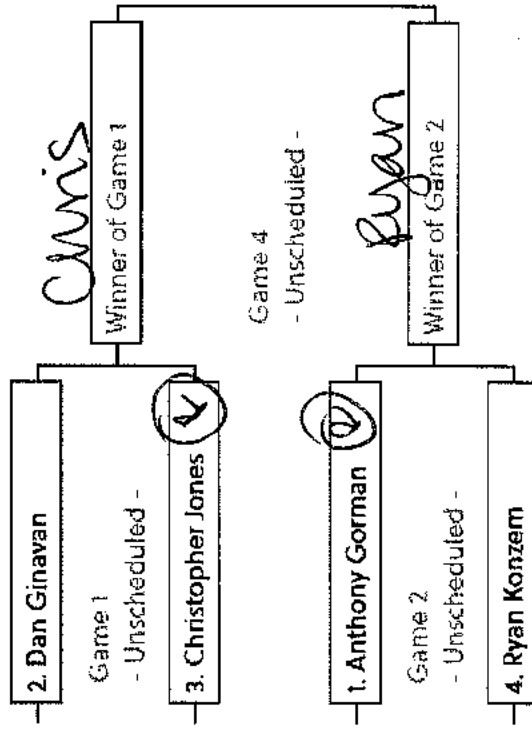

DAN (circled)

Anthony (circled)

1st Ryan

2nd Chris

3rd DAN

M

Ryan
Jeff

MALE - GI - WHITE BELT - VETERANS 40+ - 205-215LBS

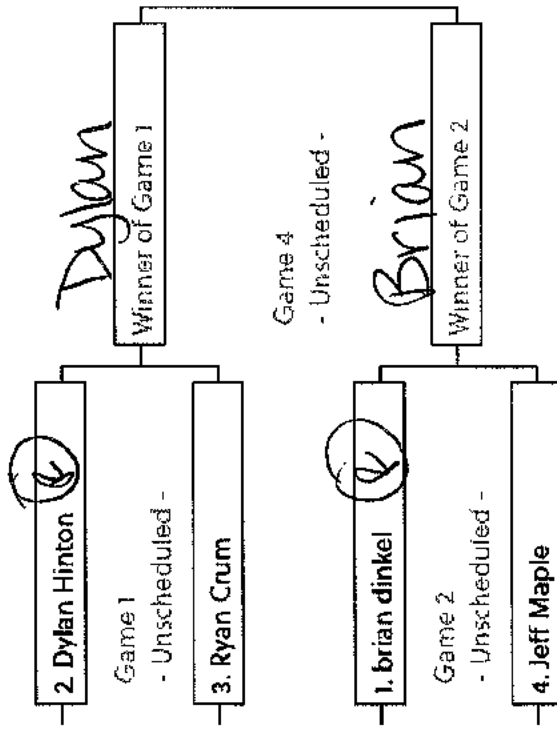

1st Dylan

2nd Brian

3rd Jeff

MALE - GI - PURPLE/BROWN/BLACK - 130-160

Tyler 1st
Aaron - 5'10"
Ene - 5'10"
20

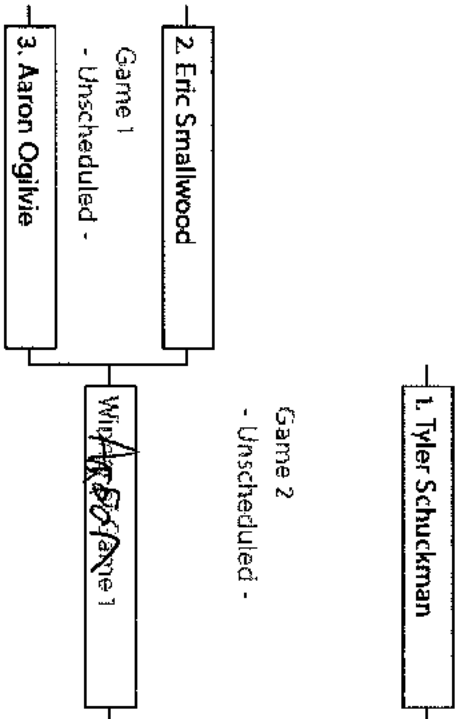

Tyler points

Tyler - 3'5"
Ene

Aaron - 5'10"

~~Tyler~~
~~Aaron~~
~~Ene~~

7

Male No GI Pro Absolute \$1000

| Name | Team |
|-------------------|--------------|
| Justin Fabac ✓ | KCBJJ |
| Cam Coquyt ✓ | KCBJJ |
| Shane Hutchison ✓ | Independent |
| Derrick Flaig | No Coact BJJ |
| Sean French ✓ | ATTKC |
| Isaac Doolittle ✓ | RS MMA |

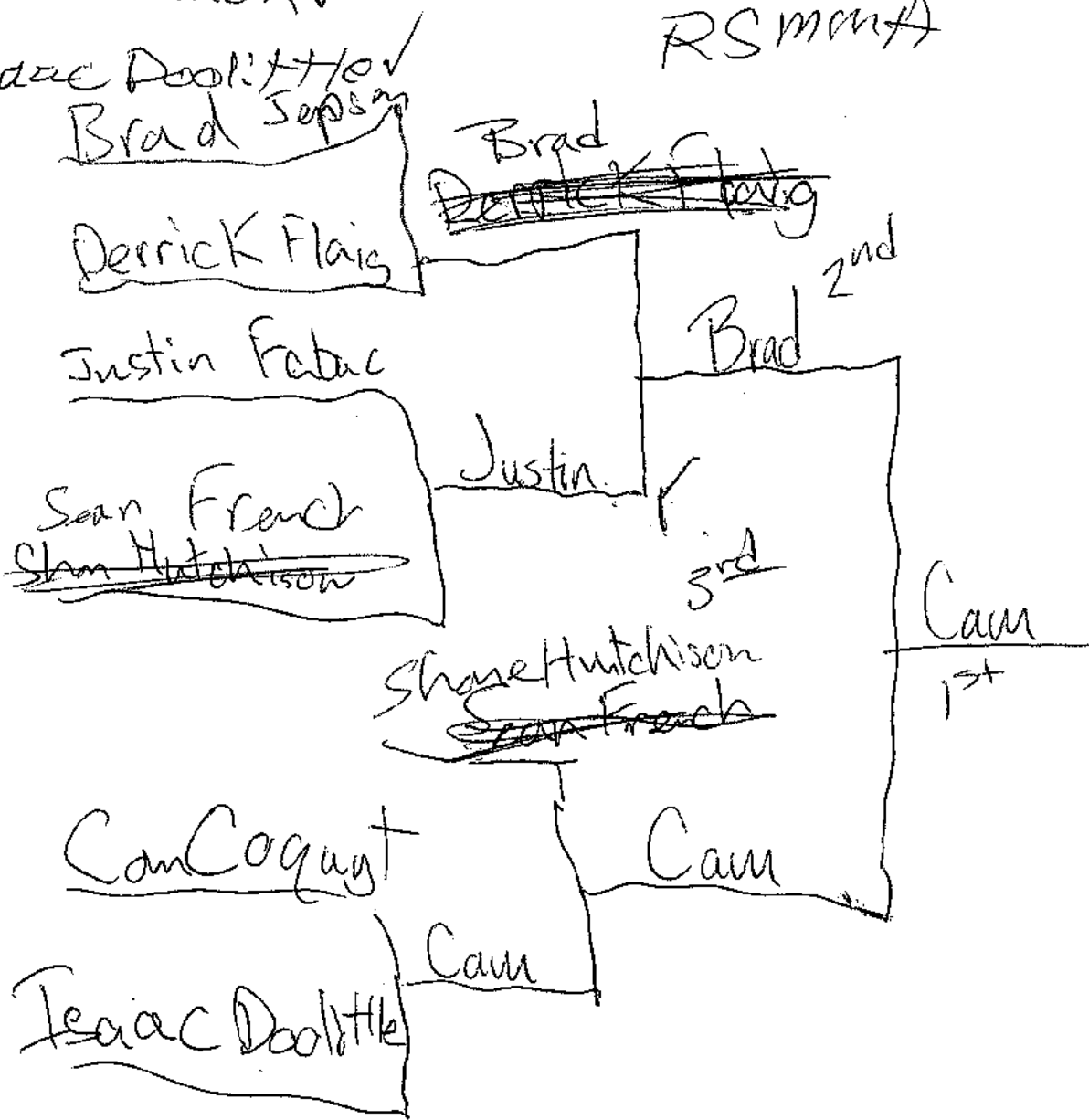

6 min

5

MALE - NOGI - INT - 155-167

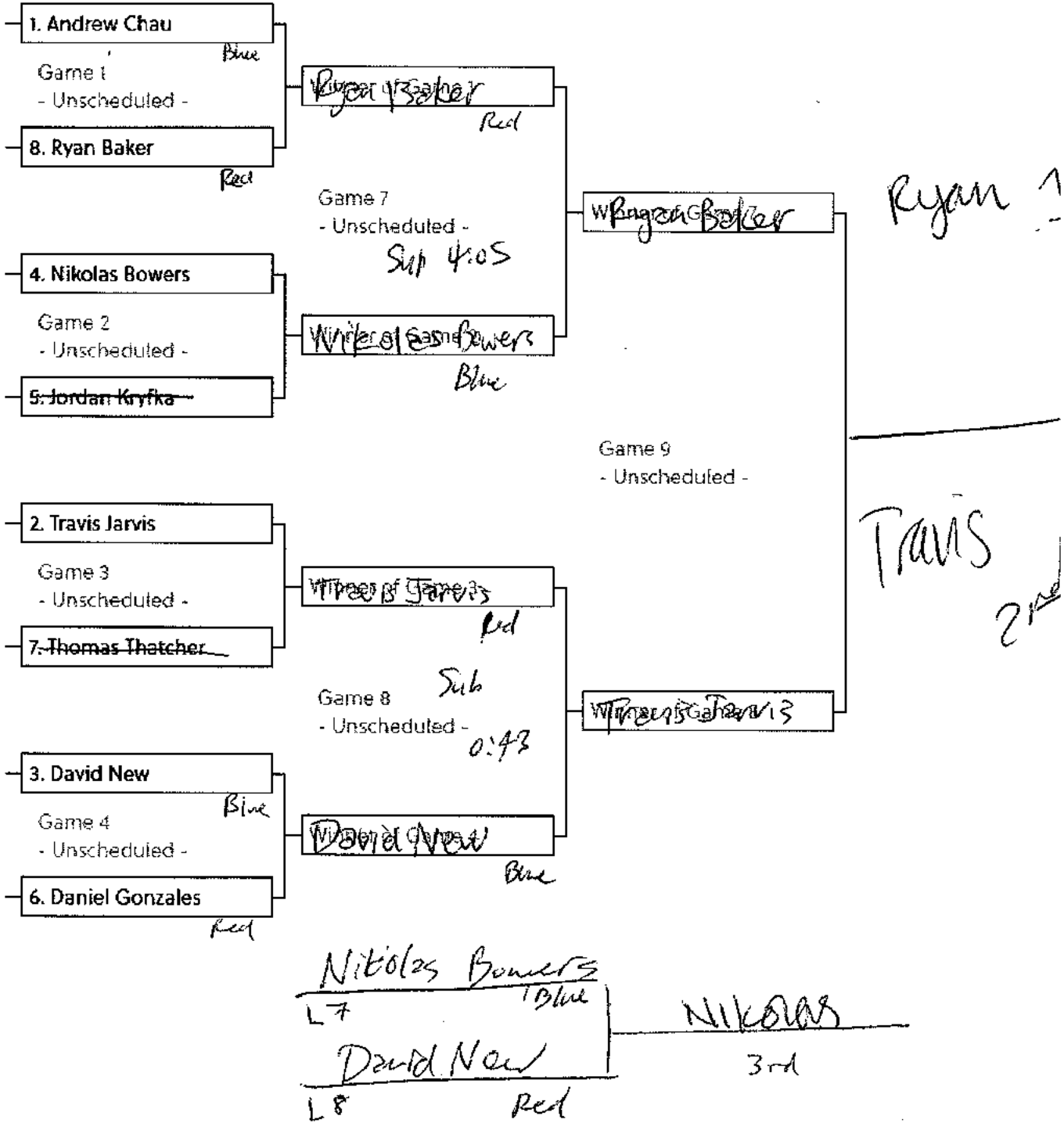

MALE - NOGI - PRO - 180-200

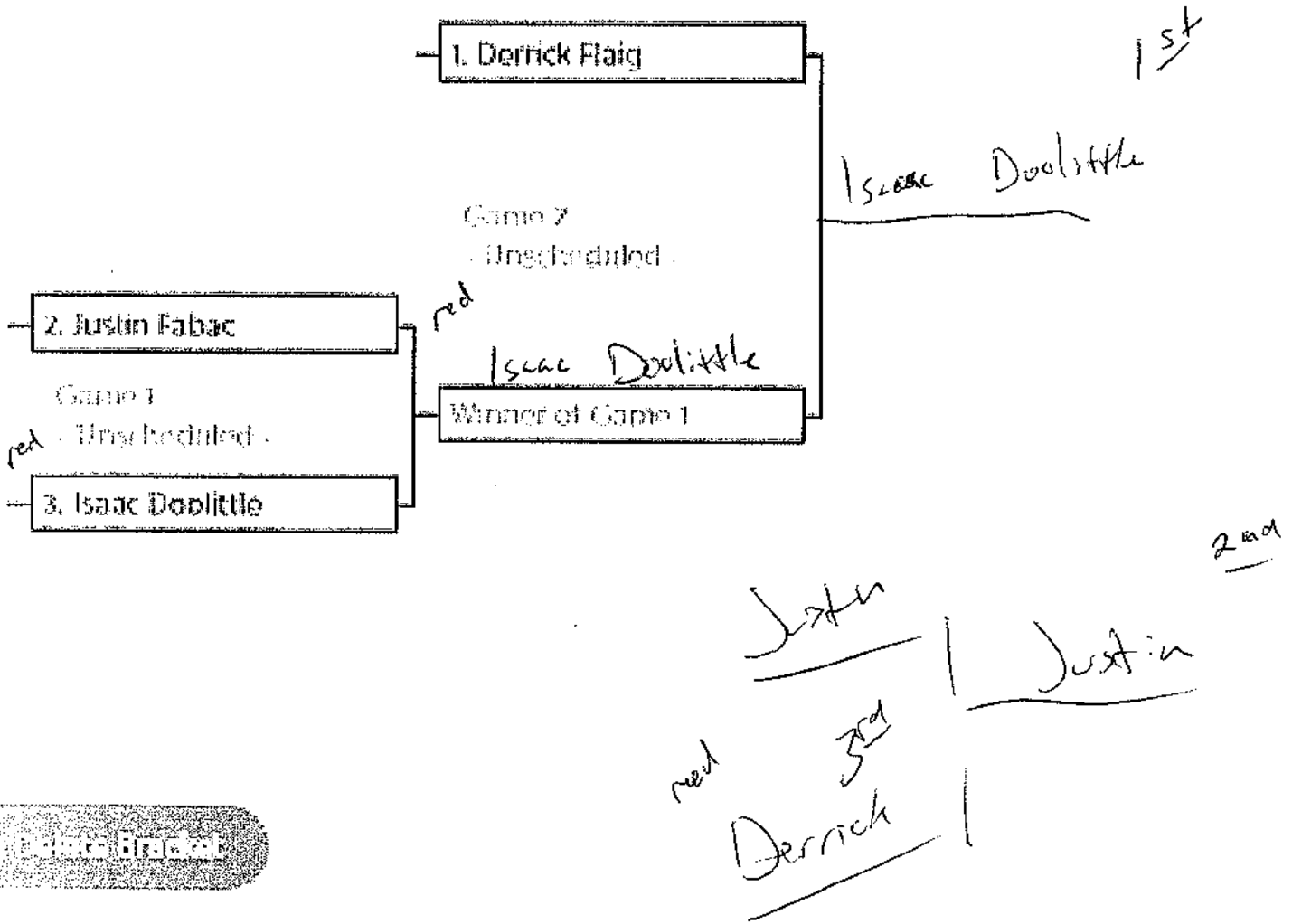

WAK UO GI Advanced Absolute

| Name | Team |
|-----------------|-----------|
| Nick Radtka | SJBJJ |
| Marquesz Franks | Valor MMA |
| Jerome Newman | KC BJJ |
| Shawn Aldrich | Valor MMA |
| Carl Springer | RBS |
| Ricky Meritz | ATTKC |

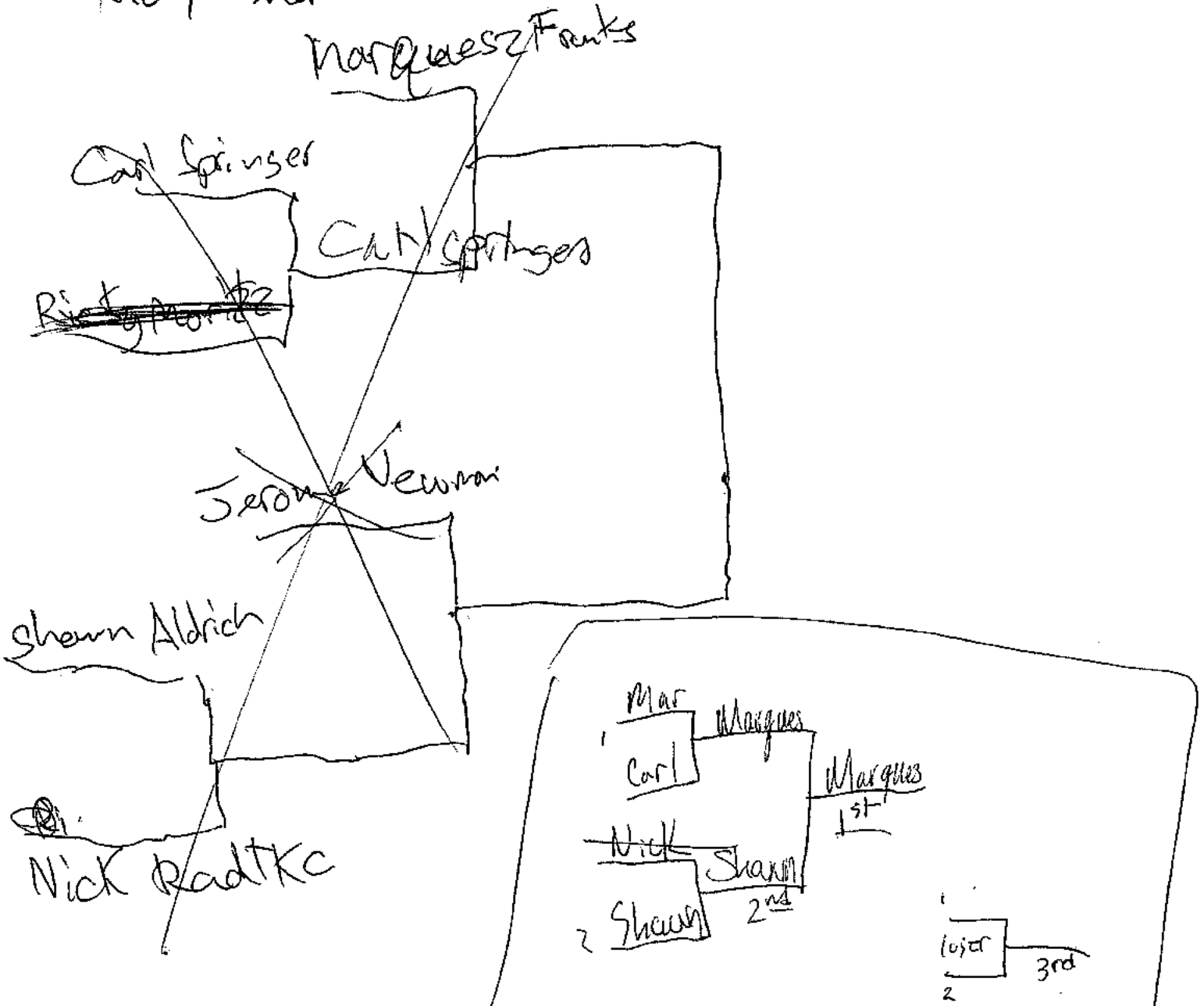

male

Nachintermediäre Absolute

~~Buck Rist~~
~~Lang~~

Jacob Wampfler

Jacob Wampfler

~~Fred~~

~~Trent~~

2nd

Martin Robinson

~~Martin Robinson~~

Martin Robinson

~~Was Miller~~

Martin Robinson

Jacob Thrall

1st

Tyler Horton

~~Jacob~~

~~Jacob Thrall~~

~~Jacob Thrall~~

~~Jacob Thrall~~

~~Jacob Thrall~~

Tyler Horton

~~Tyler Horton~~

Tyler Horton

~~Buck Rist~~

Tanner Schaefer

Tyler Horton

Jacob's

3rd

~~Jacob Wampfler~~

Tanner

Tanner

Male Nogi Beg Absolute

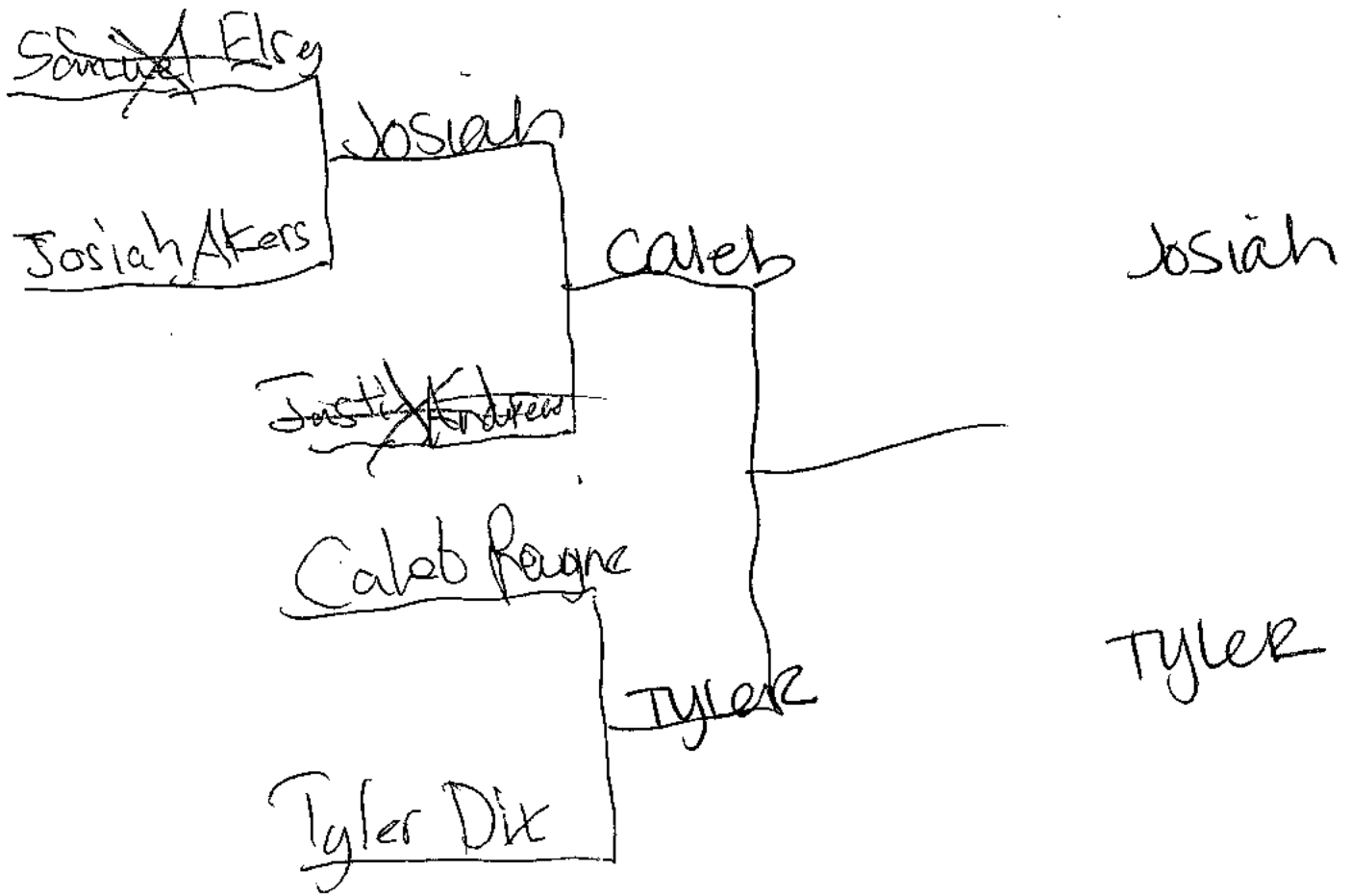

1st Caleb 2nd Tyler 3rd Josiah

5

Adult Games

6 min

MALE - NOGI - INT - 40+ - 200-221

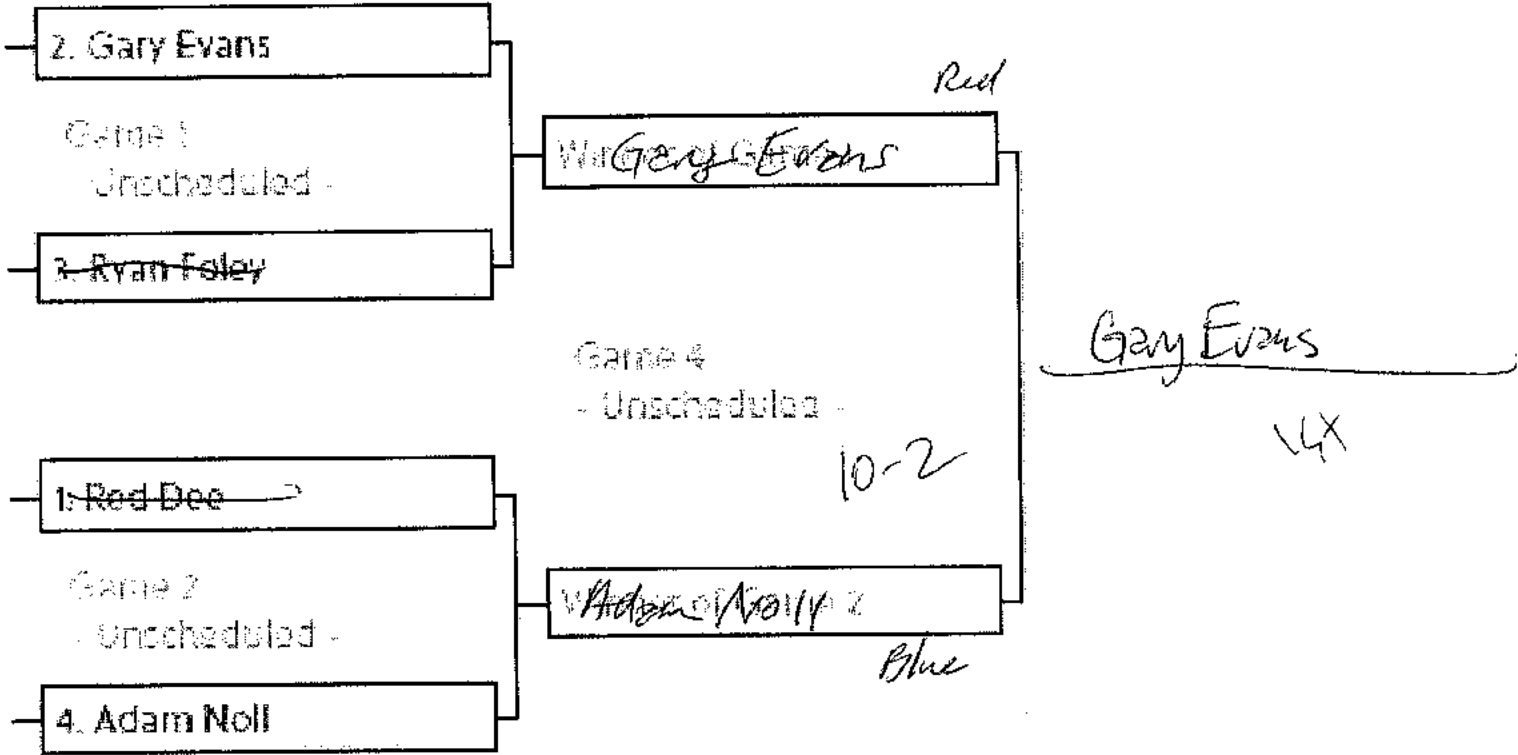

Q

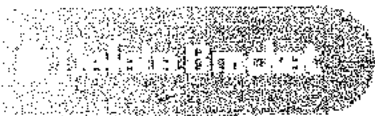

MALE - NOGI - ADV - 30+ - 182-194

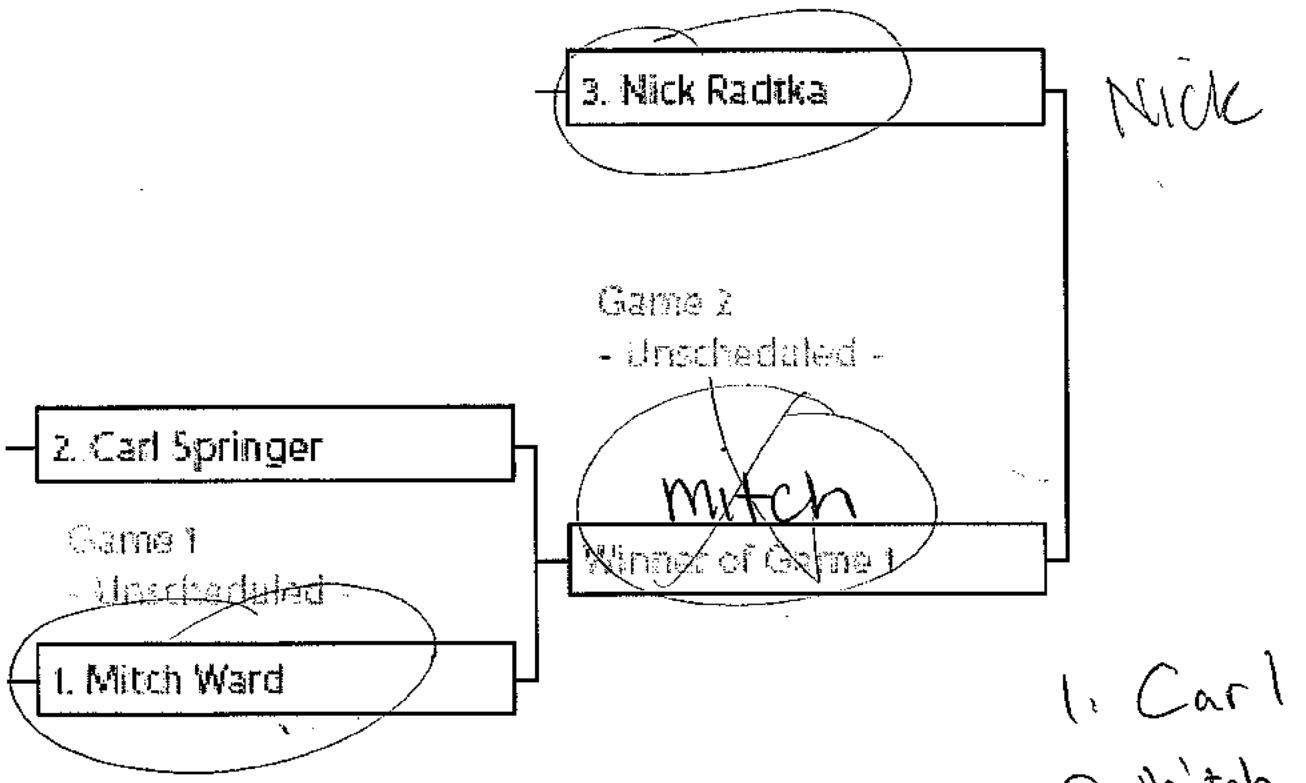

- 1. Carl
- 2. Mitch
- 3. Nick

CARL

~~NICK~~

2nd

3rd

~~Carl~~

1st

1st



MALE - NOGI - INT - 182-202

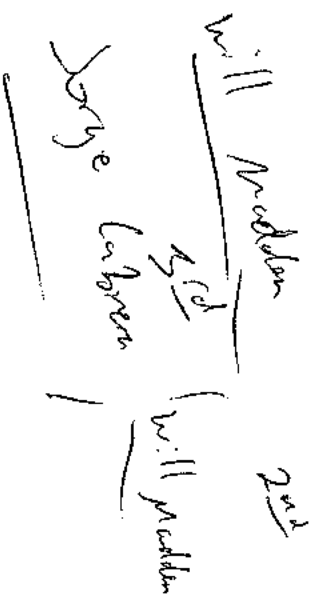
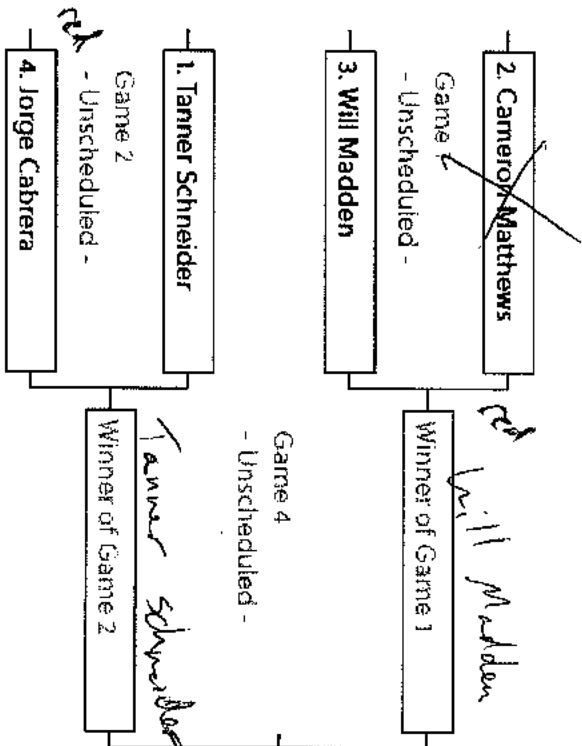

MALE - NOGI - INT - 168-181

Edgardo (F)

3. Edgardo Melo (F)

Game 2
- Unscheduled -

2. Samuel Port

Sam
Winner of Game 2

Game 4
- Unscheduled -

Branden

4. Craig Fairley Jr.

Game 1
- Unscheduled -

5. Sam Hofelt (F)

Craig
Winner of Game 1

Game 3
- Unscheduled -

1. Brandon Hutton

Craig
Winner of Game 3

1st Craig

2nd Sam

(Edgardo) 3rd Julian

MALE - NOGI - BEG -195-221

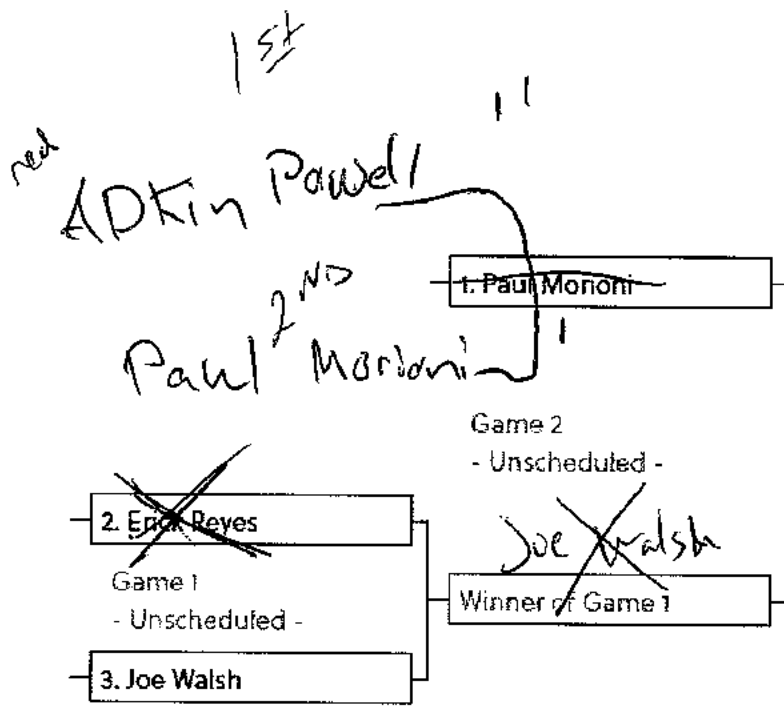

MALE - NOGI - BEG - 168-181

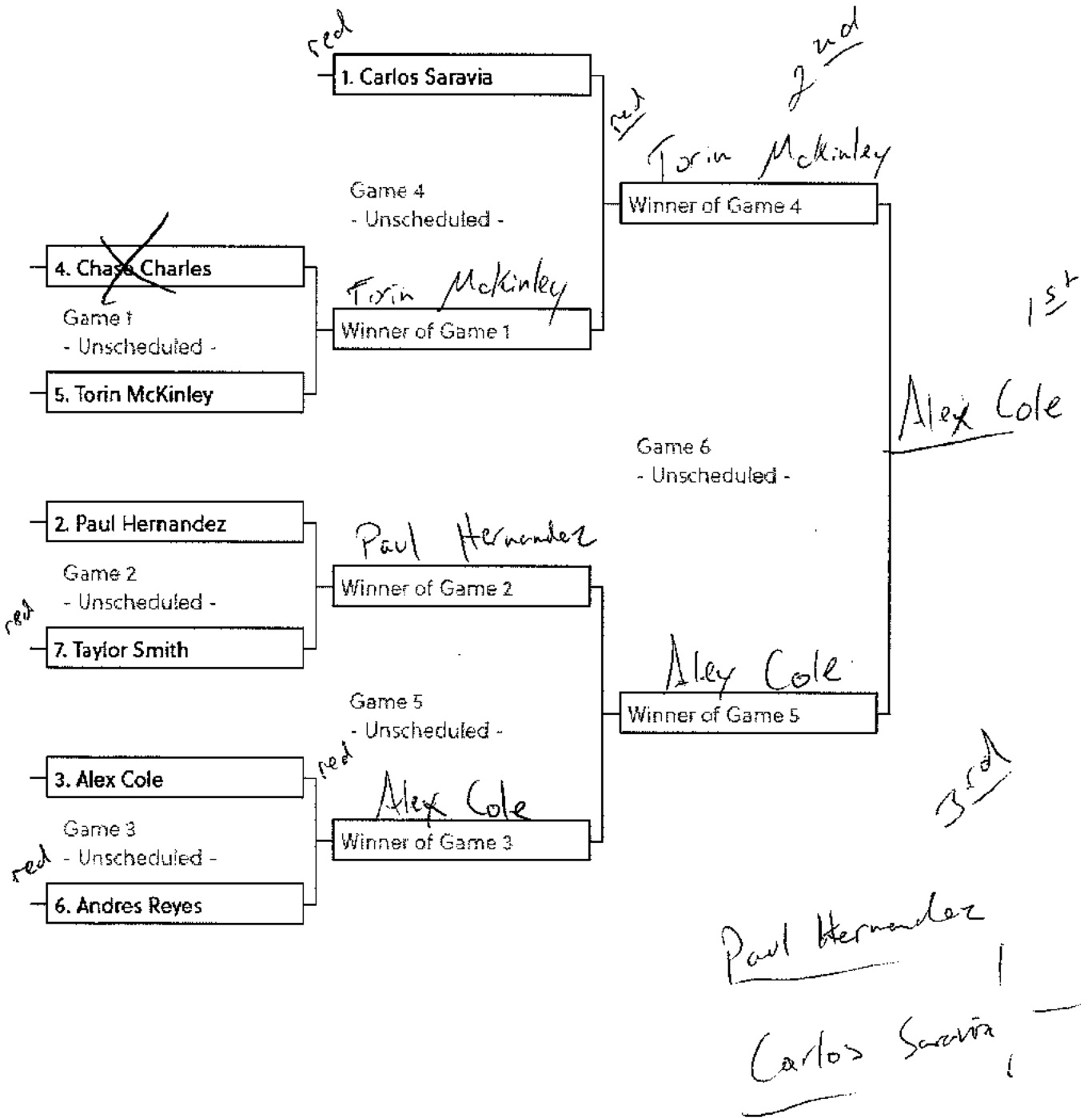

MALE - NOGI - BEG - 30+ - 210-230

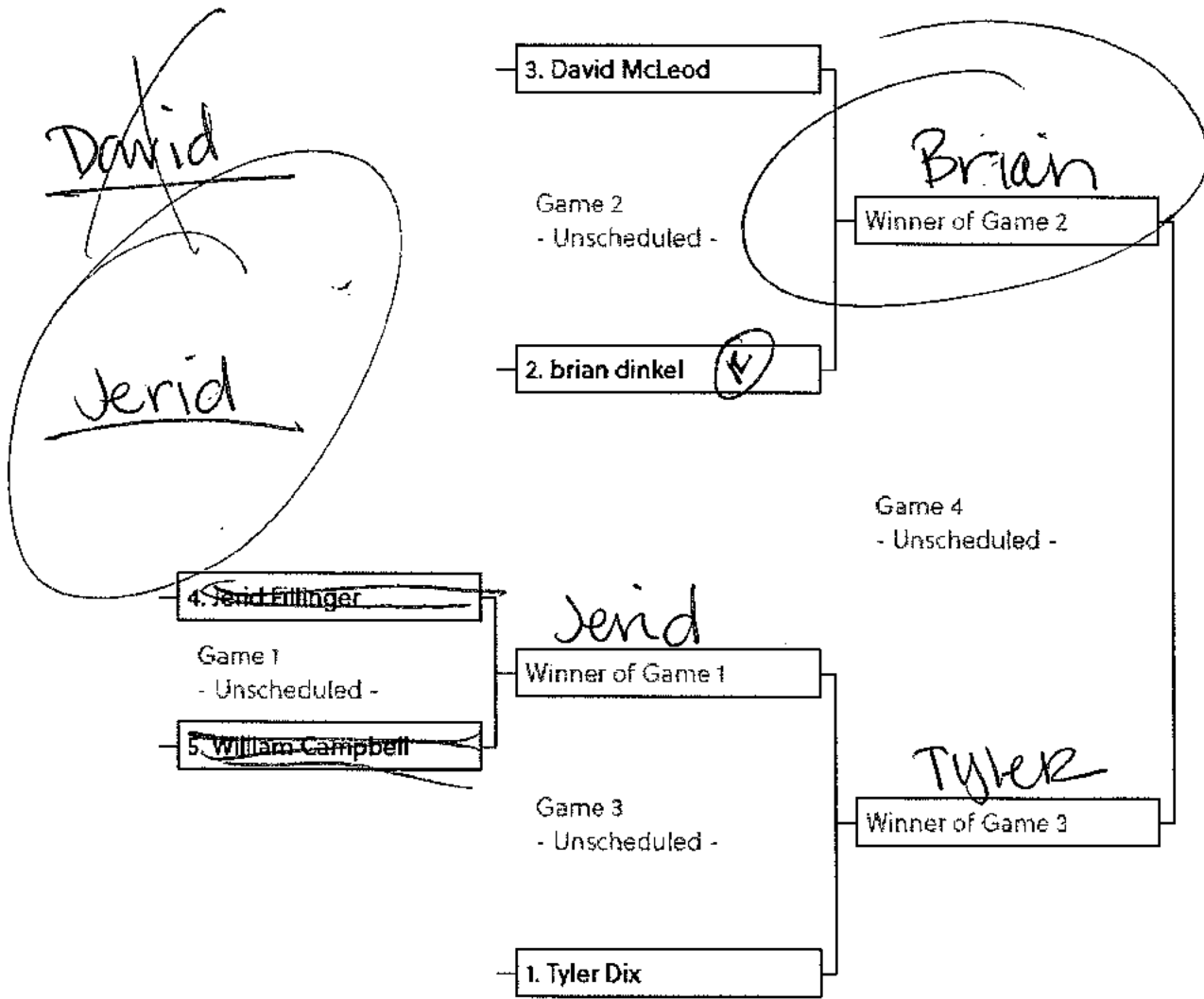

1st Brian 2nd Tyler 3rd Jerid

MALE - NOGI - PRO - 150-175

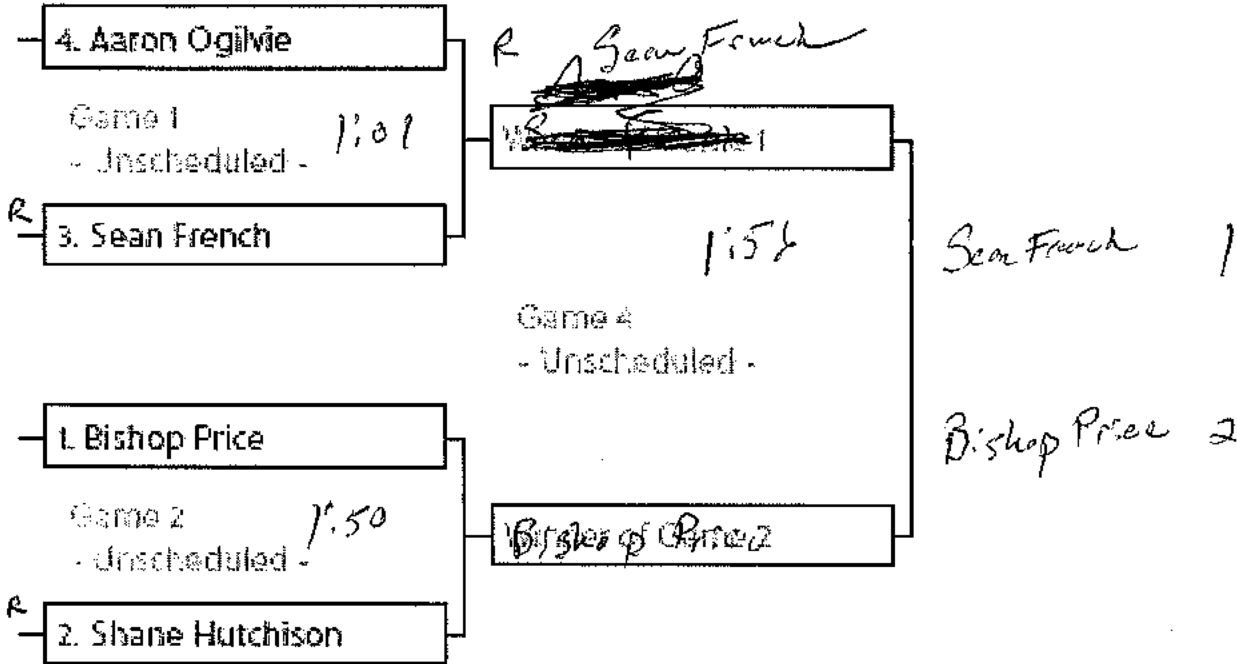

~~Shane Hutchison~~

Aaron Ogilvie
2:06
Shane Hutchison

Aaron Ogilvie 3



MALE - NOGI - INT - 30+ - 190-195

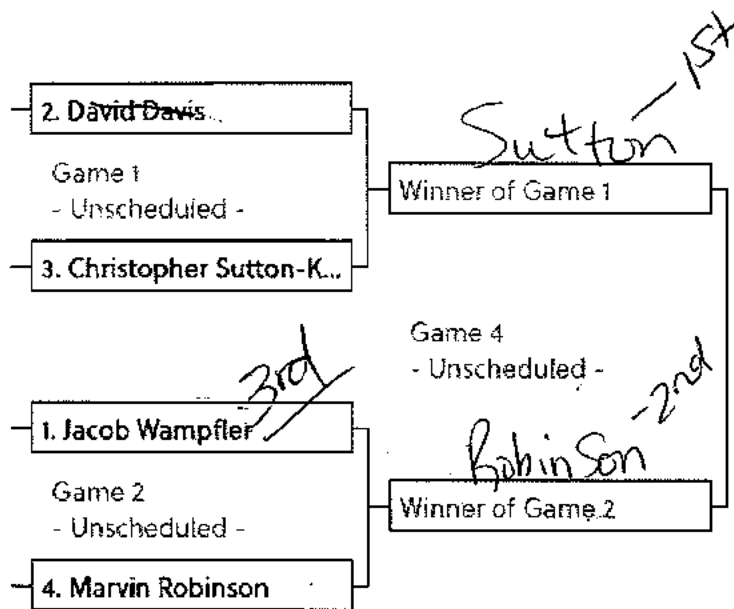

MALE - NOGI - INT - 30+ - 208-221

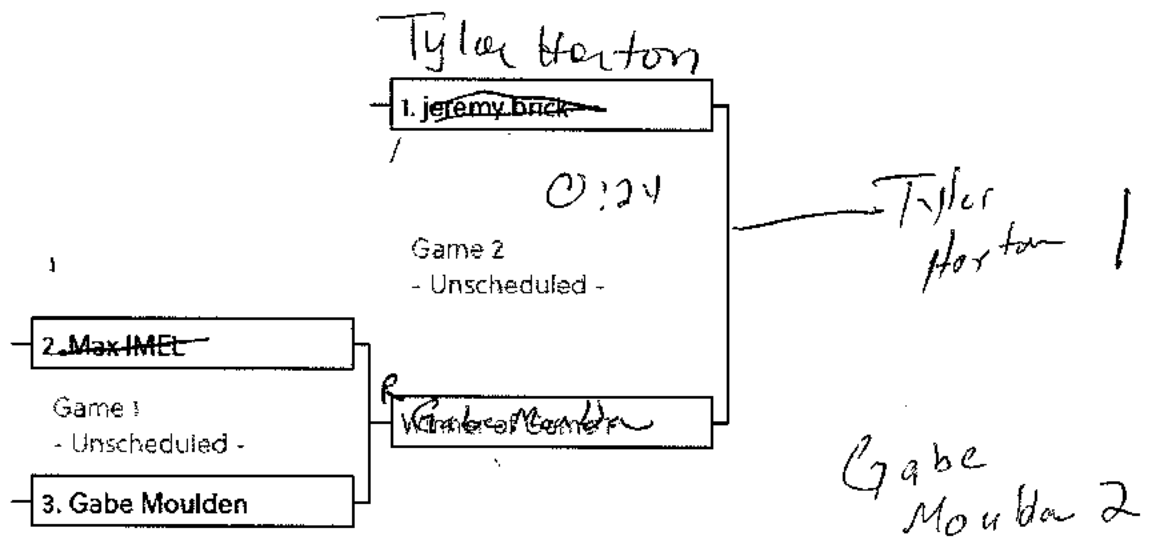

MALE - NOGI - BEG - 182-194

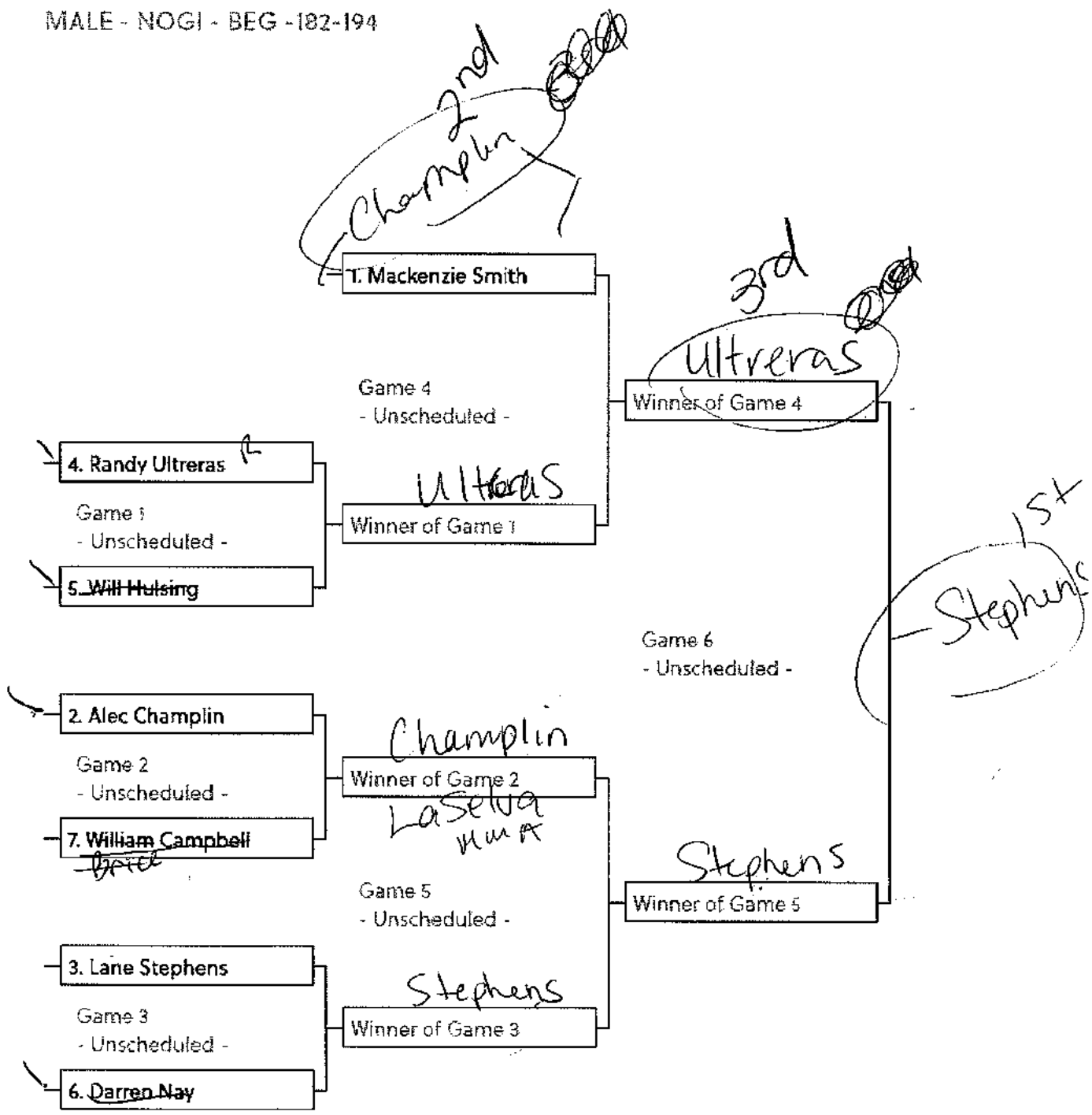

PM

MALE - NOGI - INT - 30-49 - 130-154

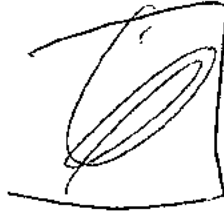

2
3. Yang Zou

Game 2
- Unscheduled -

Winner of Game 2

zad
2. Nathan Dahlgren

Game 4
- Unscheduled -

ASA 1st

~~4. Wes Miller~~

Game 1
- Unscheduled

Winner of Game 1

5. Asa Collier

Game 3
- Unscheduled -

Winner of Game 3

ASA

~~1. [unclear]~~

NATHAN

ASA

MALE - NOGI - INT - 19-39 - ABOVE 221

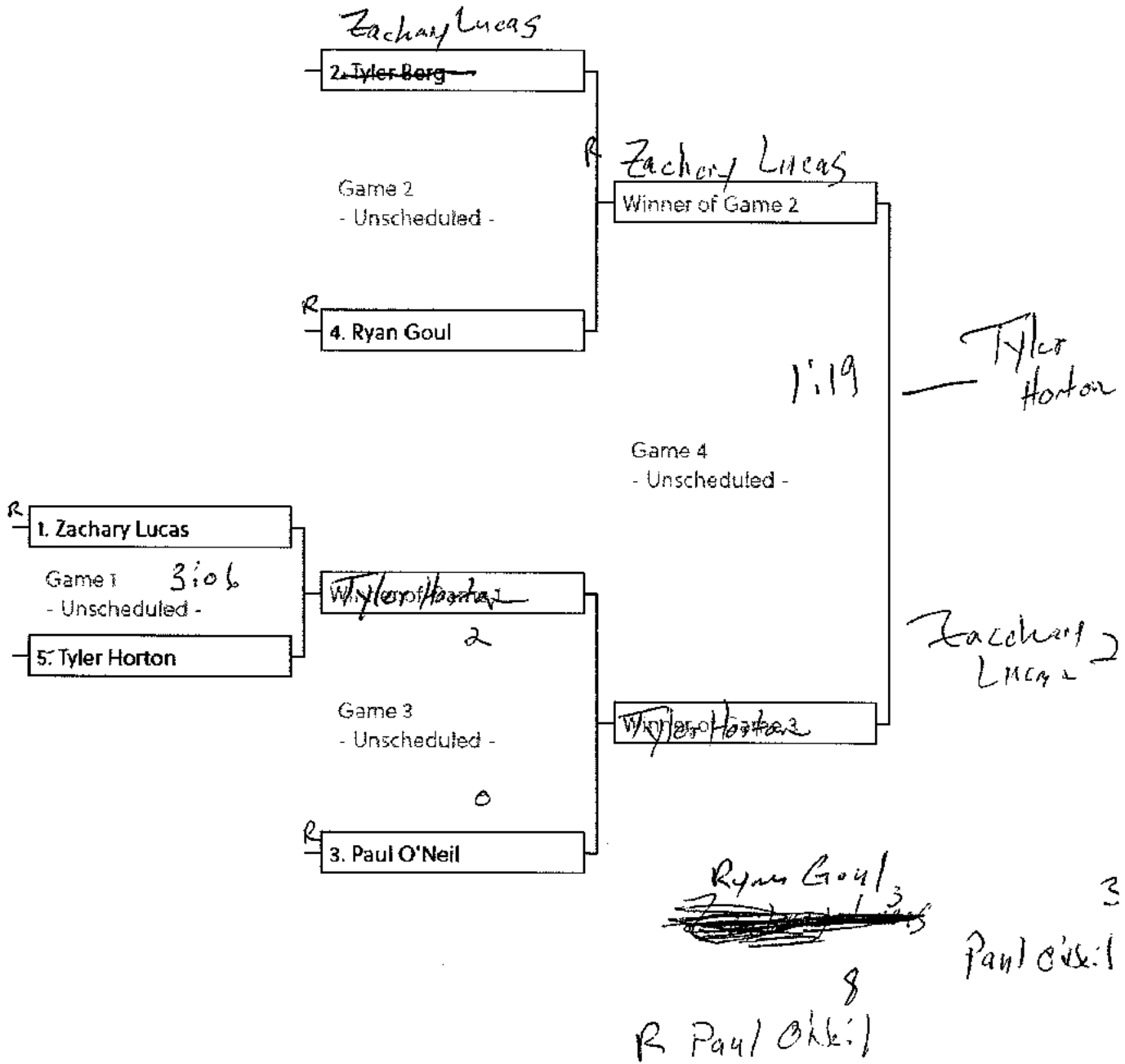

MALE - NOGI - BEG - 30+ - 195-207

(R) William

max

MAXIMO

1. Maximo Mayugba

Game 2
- Unscheduled -

2. Gabriel Maldonado

Game 4
- Unscheduled -

4. William Kelly

Game 1
- Unscheduled -

(R) 5. Casey Beggs

Game 3
- Unscheduled -

GRANT

Winners of game 3



Lose

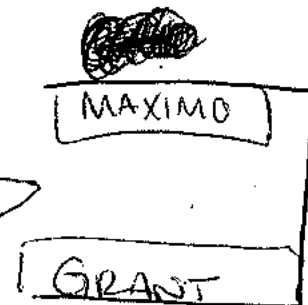

MAXIMO
3rd

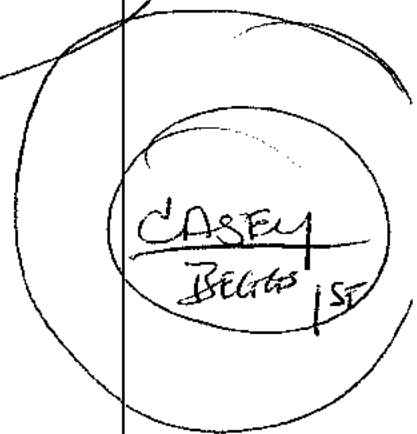
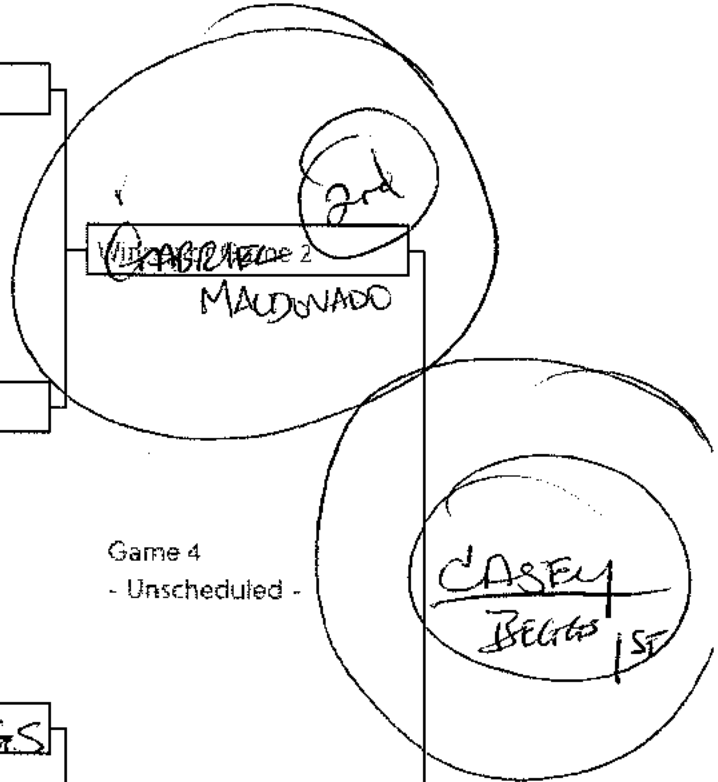

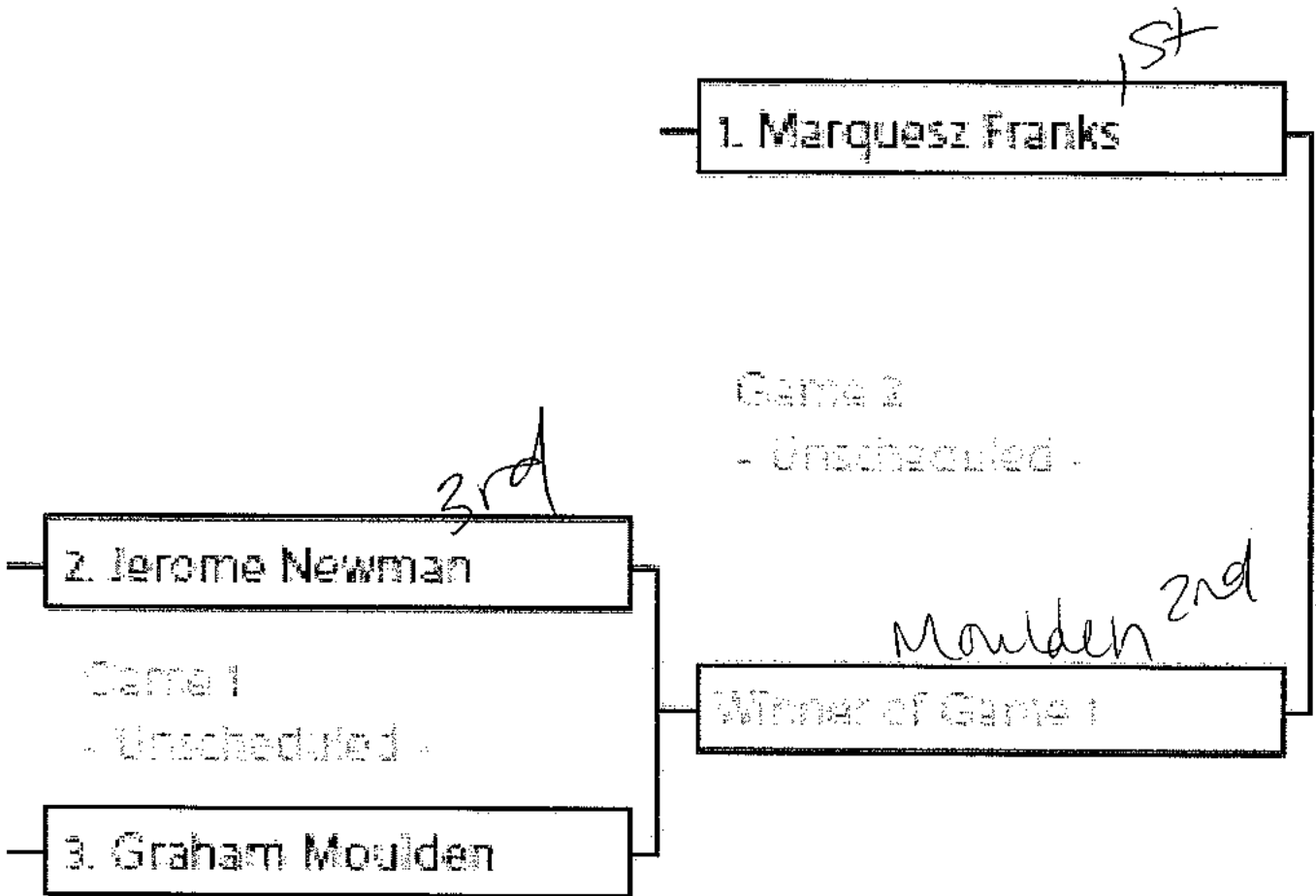

2

MALE - NOGI - INT - 30+ - 180-187

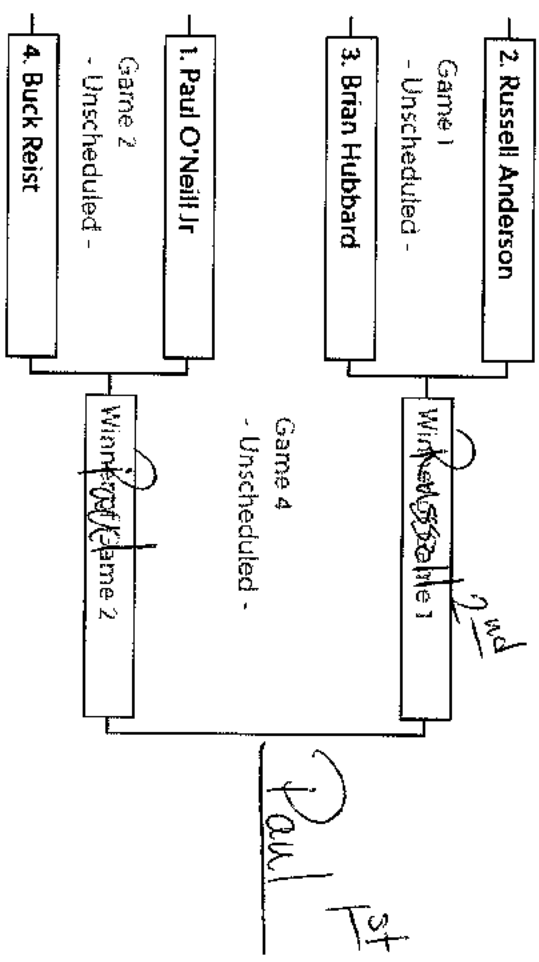

Brian
 Brian 1
 Buck 3rd

7

MALE - NOGI - PRO - 215-250

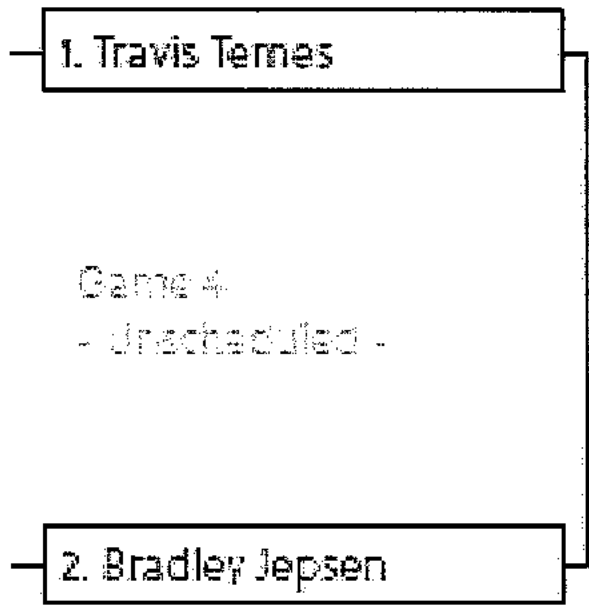

W



MALE - NOGI - INT - 40+ - 168-181

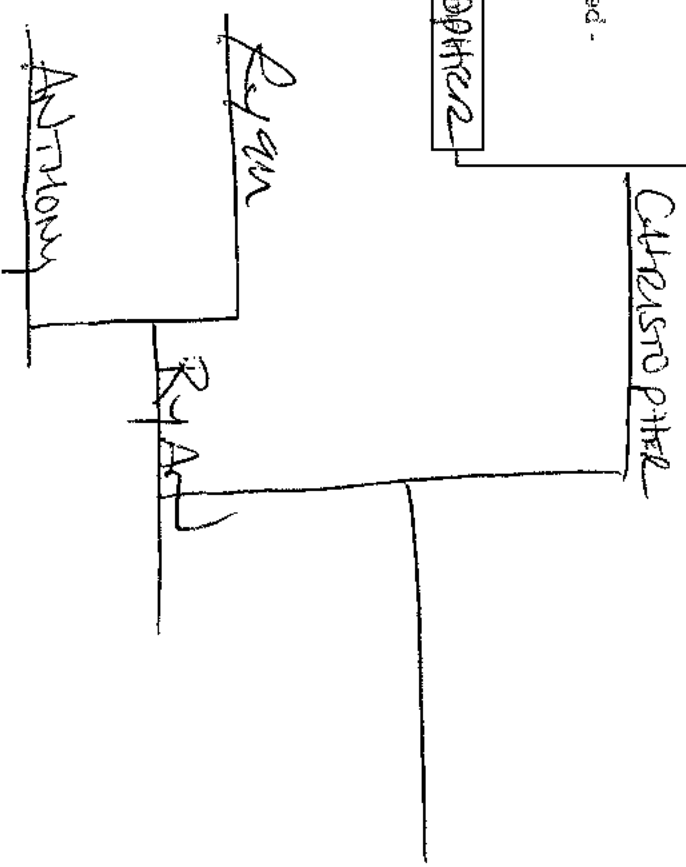
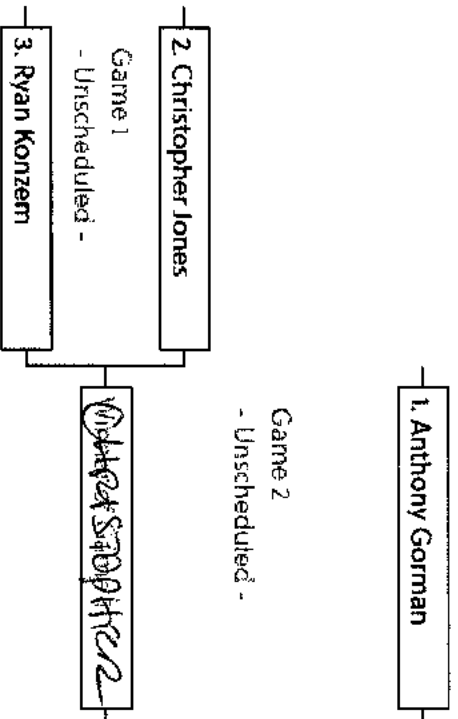

3

MALE - NOGI - INT - 30+ - 155-167

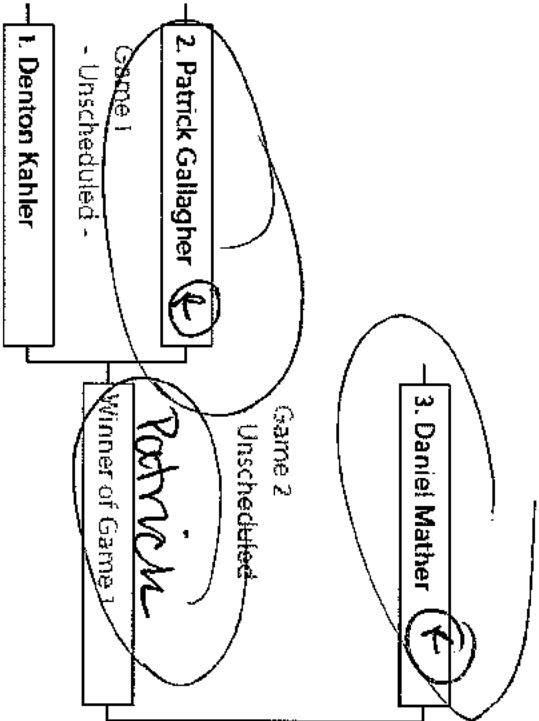

Daniel

Denton

1st Patrick

2nd Daniel

2nd Denton

6

MALE - NOGI - ADV - 301 - 200-210

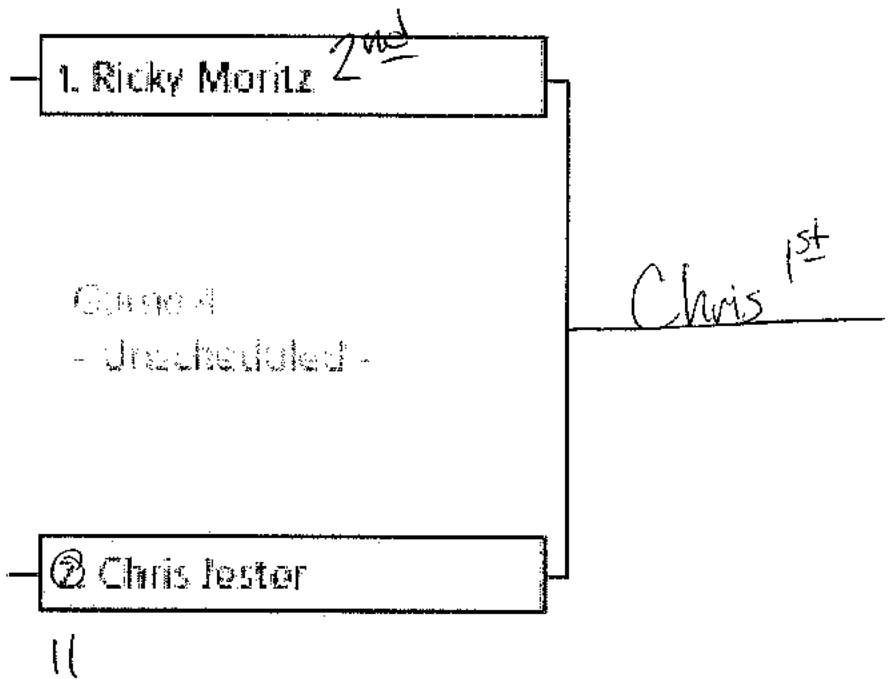

MALE - NOGI - BEG - 128-148

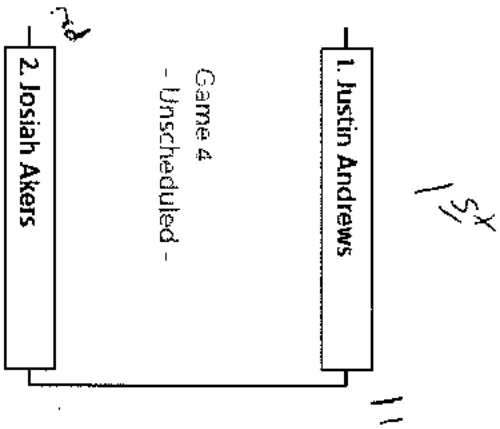

MALE - NOGI - BEG - 30+ -168-181

R Jason Adkins

0:43

Corey Harvey

Corey Harvey

~~1. Corey Harvey~~

Game 2
- Unscheduled -

Leroy Slater)

2. Leroy Slater 12

Game 1
- Unscheduled -

R Winner of Slater

R 3. Matt Thomas 0

Corey Harvey 2

Jason Adkins
1:51

R Matt Thomas

→ 3

MALE - NOGI - ADV - 155-181

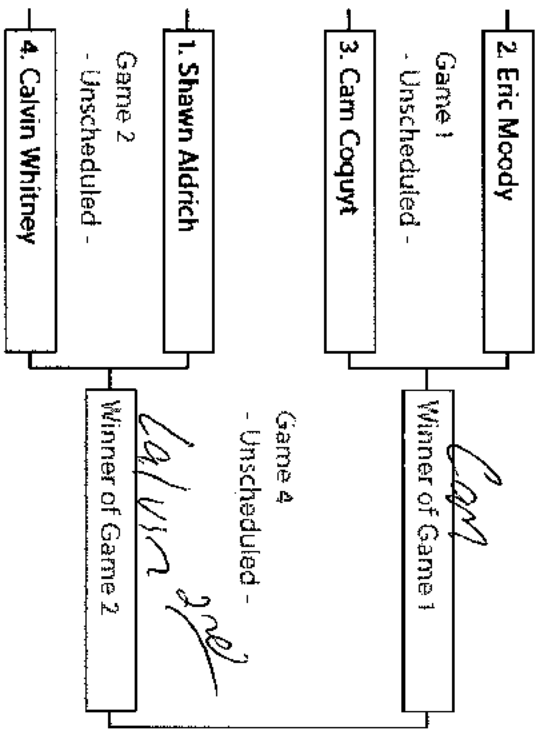

Eric -
Shawn
3rd

Cam
1st

Cam 1st
Calvin 2nd
Eric 3rd

MALE - NOGI - INT - 140-154

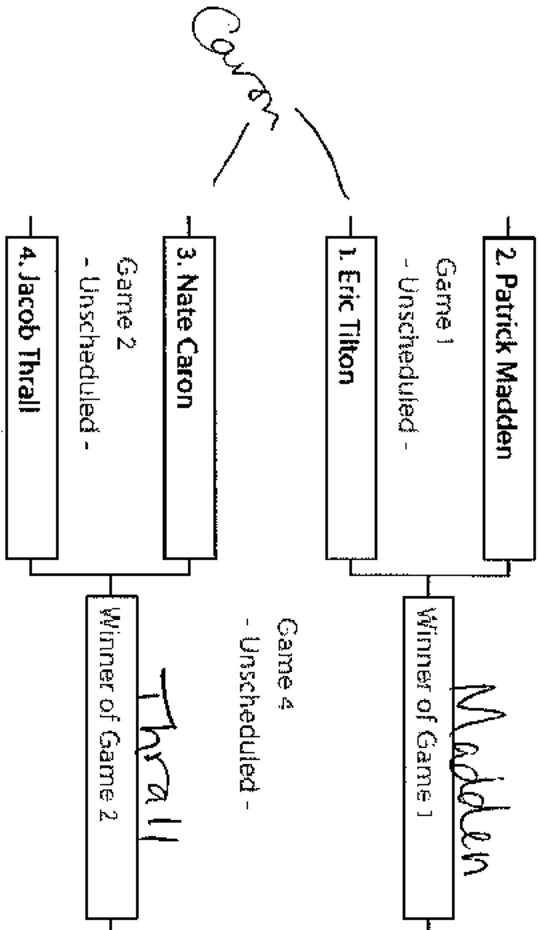

Madden
Thrall

Game 4
- Unscheduled -

Caron

1st
Thrall
2nd
Madden
3rd
Caron

2

MALE - NOGI - BEG - 40+ 195-207

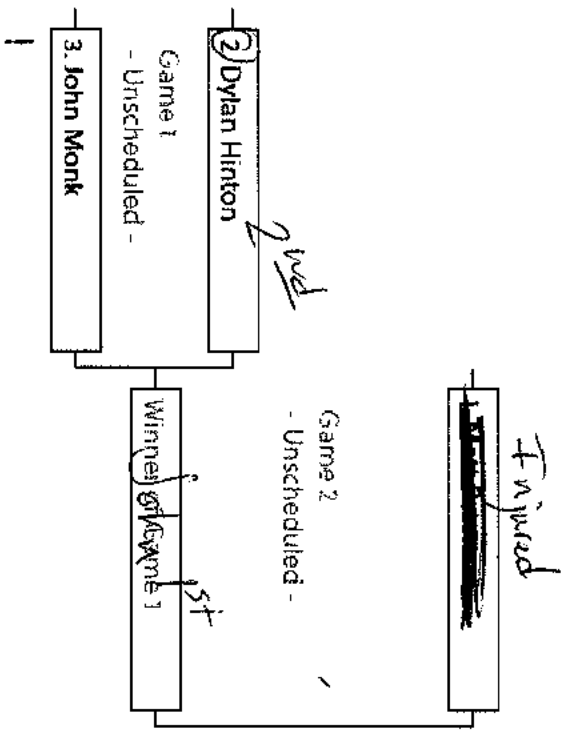

2

MALE - NOGI - BEG - 30+ - ABOVE 250

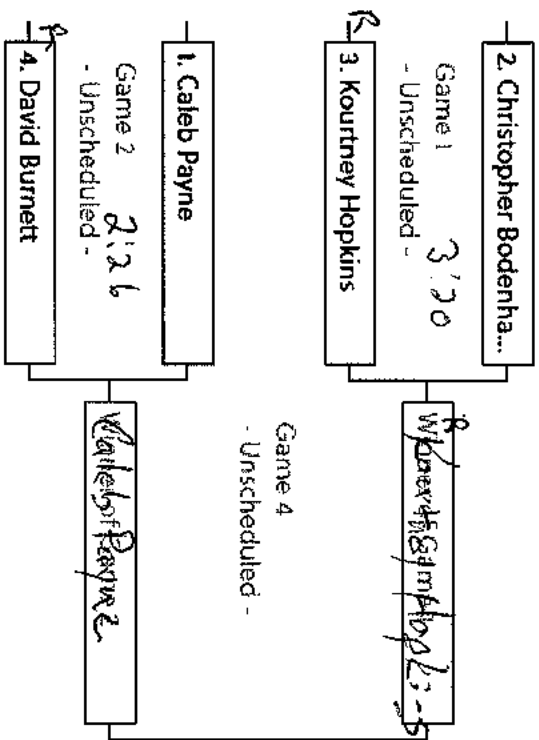

Caleb Payne 1

Kourtney Hopkins 2

Chris Bodenhamer 2:58

David Burnett



5 min

5

MALE - NOGI - BEG - 150-154

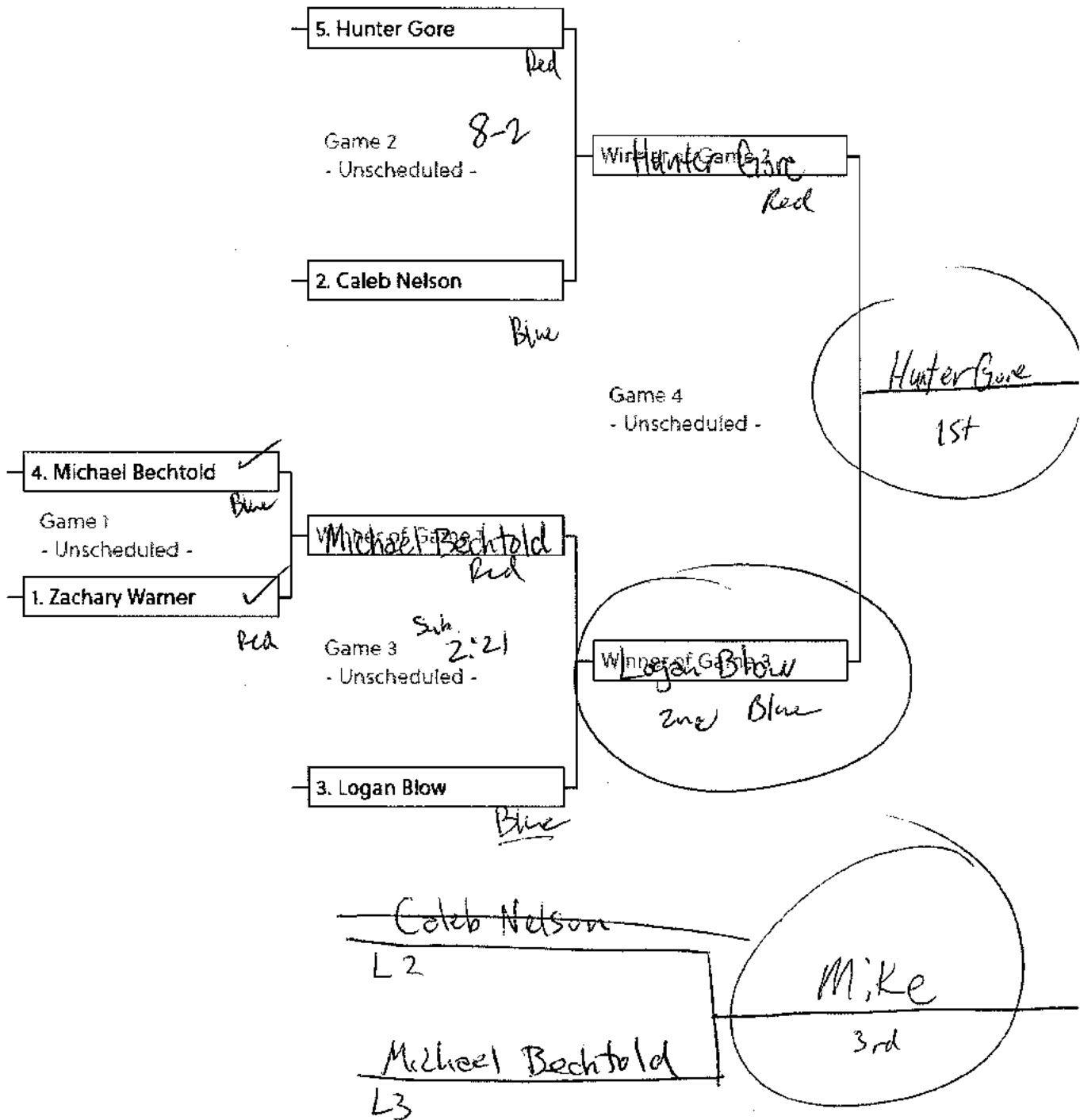

7

Mark - 1 point
Cody - Disub
Wade - 05

MALE - NOGI - BEG - 30+ - 142-167

Mark 3/11/8
~~Cody~~
~~Wade~~

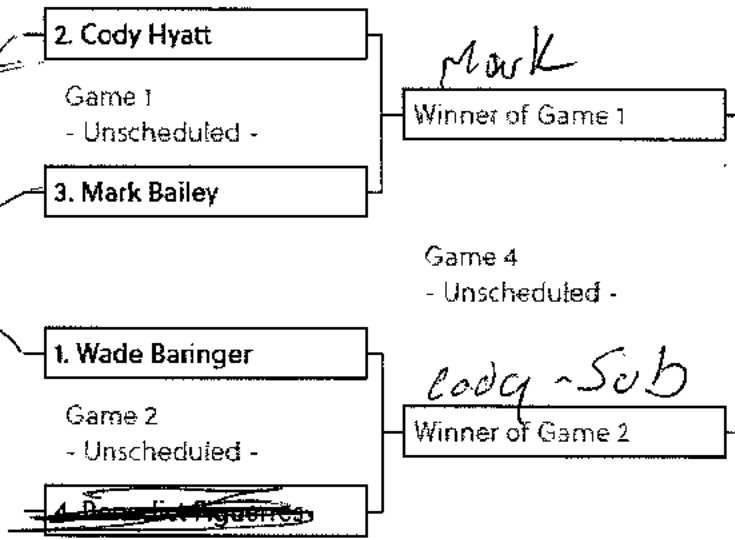

Cody 1st
Mark 2nd
Wade 3rd

wade -
cody